

Quick Start for Dynamixel Pro



ROBOTIS

CONTENTS

CONTENTS	2
1 Tutorial	5
1.1 RoboPlus	5
1.1.1 Preparation	5
i. RoboPlus installation (Windows only)	5
ii. Wiring of Dynamixel PRO 54 series.....	5
iii. Wiring of Dynamixel PRO 42 series.....	6
iv. Wiring of Dynamixel PRO 54 & 42 series	6
v. USB-to-Dynamixel dongle (RS485 setting).....	7
vi. COM Port Latency Time setting.....	7
1.1.2 Dynamixel Wizard	9
i. Operating a Dynamixel PRO.....	9
ii. Operating Dynamixel PRO in Wheel Mode.....	14
iii. LED Control of Dynamixel PRO	18
iv. ID configuration	19
v. Modifying the baud rate	20
vi. Accelerating Dynamixel PRO in Joint Mode.....	21
vii. Limiting the range of motion of Dynamixel PRO.....	23
viii. Extending the range of motion of Dynamixel PRO.....	25
ix. Accelerating Dynamixel PRO in Wheel Mode.....	27
x. Refer to ‘1.1.2. ii ‘Operating Dynamixel PRO in Wheel Mode’	27
xi. Torque Mode of Dynamixel PRO	29
xii. Update Dynamixel PRO’s firmware.....	31
xiii. Dynamixel PRO Firmware Recovery with Dynamixel Wizard.....	34
1.2 Visual Studio 2010	38
1.2.1 Preparation	38
i. Setting the development environment	38
ii. Initialize and terminate the connection with USB-to-Dynamixel dongle.....	41
1.2.2 Basic functions of Dynamixel PRO	43
i. Turning the torque On/Off of Dynamixel PRO.	43
ii. Operating Dynamixel PRO using C programming language.....	45

iii.	Modifying Dynamixel PRO’s ID using C programming language.....	47
iv.	Modifying the baud rate of Dynamixel PRO.	49
v.	LED control of Dynamixel PRO.....	53
vi.	Modifying the P gain value of Dynamixel PRO.....	56
vii.	Operating Dynamixel PRO in various speeds.....	60
viii.	Internal temperature feedback of Dynamixel PRO.....	64
x.	Changing velocity of Dynamixel PRO in Wheel Mode	69
xi.	Checking the current position and current velocity of Dynamixel PRO	72
1.2.3	C programming language funtions.....	76
i.	Modifying the zero value of Dynamixel PRO	76
ii.	Limiting the operating range of Dynamixel PRO	79
iii.	Extending the operating range of Dynamixel PRO.	83
1.2.4	Indirect Addressing function of Dynamixel PRO.....	87
i.	Change the position, velocity, and acceleration using Indirect Address fuction.	87
ii.	Reading the temperature and the current position using Indirect Address.....	93
1.2.5	Using Multiple Dynamixel PROs.....	97
i.	Controlling the LEDs of 3 Dynamixel PROs.....	97
ii.	Controlling the Goal Position of 3 Dynamixel PRO	100
iii.	Reading the the Current Position of 3 Dynamixel PROs	103
iv.	Read temperature of the first, position of the second, and present current of the third Dynamixel PRO	106
1.3	Linux.....	109
1.3.1	Set-up.....	109
i.	Checking USB-to-Dynamixel connection in Linux	109
2	Reference	129
2.1	Default values by model.....	129
2.1.1	H Series	129
i.	H54-200-S500-R	129
ii.	H54-100-S500-R	129
iii.	H42-20-S300-R	129
2.1.2	M Series	129
i.	M54-60-S250-R.....	129

- ii. M54-40-S250-R.....130
 - 2.1.3 L Series..... 130
 - i. L54-50-S290-R.....130
 - ii. L54-30-S400-R.....130
 - iii. L42-10-S300-R.....130
- 2.2 Control Table of Dynamixel Pro 131
- 2.3 Features (by width size)..... 132
 - 2.3.1 54-series (H54, M54, L54)..... 132
 - 2.3.2 42-series (H42, L42) 133
- 2.4 Dimensions..... 134
 - 2.4.1 H Series 134
 - i. H54-200-S500-R 134
 - ii. H54-100-S500-R 134
 - iii. H42-20-S300-R 135
 - 2.4.2 M Series 135
 - i. M54-60-S250-R.....135
 - ii. M54-40-S250-R.....135
 - 2.4.3 L Series..... 137
 - i. L54-50-S290-R.....137
 - ii. L54-30-S400-R.....137
 - iii. L42-10-S300-R.....138
- 2.5 Model notation..... 139

1 Tutorial

This guide is written for first-time Dynamixel PRO users, but, familiar with C and C++ programming languages.

1.1 Roboplus

1.1.1 Preparation

i. RoboPlus installation (Windows only)

- RoboPlus is a software package that allows you to easily control and program all ROBOTIS products.
- This guide contains information regarding the use of RoboPlus's Dynamixel Wizard to test Dynamixel PRO.
- You may download the most current version of RoboPlus at <http://www.robotis.com/xe/download>.

ii. Wiring of Dynamixel PRO 54 series

- To operate a Dynamixel PRO, at least, a USB-to-Dynamixel dongle and 24V power supply (for high-power operations) or ROBOTIS' conventional 12V SMPS (for low-power operations) are required.
- Dynamixel PRO 54 series can be powered via external power cable or 4-pin cable; however, it is recommended to use an external power supply (via power cable) for better stability.
- As illustrated below, use a 4-pin cable to connect the USB-to-Dynamixel dongle and Dynamixel PRO.
- Connect one end of the power cable to Dynamixel PRO; the other end to the power supply.

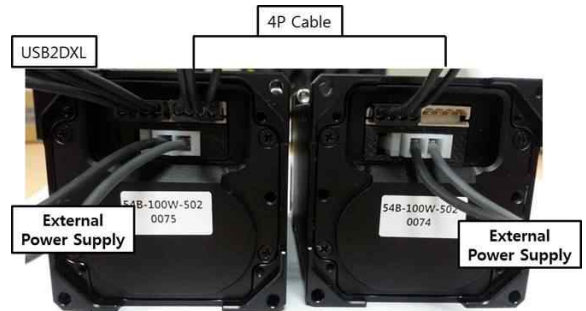
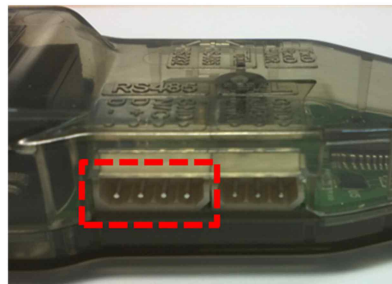

- Please note the schematic below.

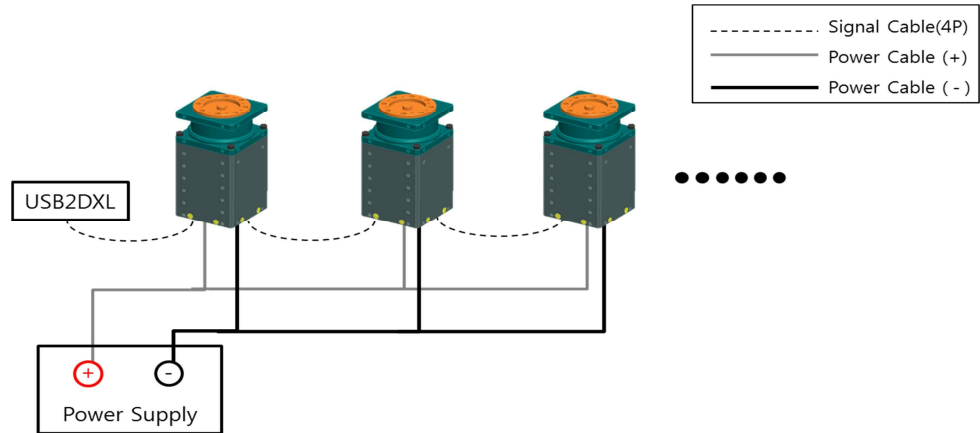

- Dynamixel PROs can be connected in series (daisy chain) with the 4-pin cables for communications (and low-power operations). However, power (high-power operations) must be supplied in parallel (individually).

iii. Wiring of Dynamixel PRO 42 series

- Similar to the 54 series, the 42 series requires a 24V power supply.
- Dynamixel PRO 42 series can be powered by the 4-pin cable (low-power operations). Connecting via SMPS-to-Dynamixel is also allowed.
- A USB-to-Dynamixel dongle connects to SMPS-to-Dynamixel; then SMPS-to-Dynamixel to Dynamixel PRO(s).



iv. Wiring of Dynamixel PRO 54 & 42 series

- First, connect an USB-to-Dynamixel dongle and Dynamixel PRO via 4-pin cable.
- Second, connect a dedicated power supply to Dynamixel PRO via power cable.

For multiple Dynamixel PROs they can be connected in series, for communications (daisy chain) and low-power operations, and parallel (individually), for high-power operations, as illustrated below.

- Please note the schematic below.

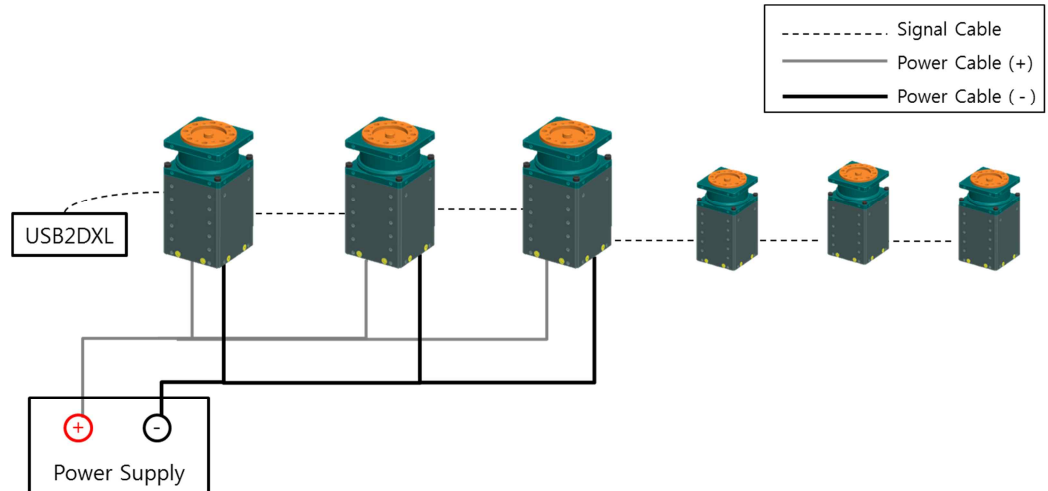

v. USB-to-Dynamixel dongle (RS485 setting)

- Dynamixel PRO communicates via RS485.
- Set the switch on the left hand side of the USB-to-Dynamixel dongle to RS485 (#2).

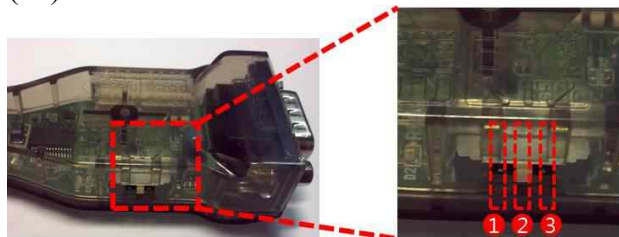

vi. COM Port Latency Time setting

- To control Dynamixel PRO using a USB-to-Dynamixel dongle, it is recommended to modify the Latency Time of the Port. Please refer to the images below to adjust the Latency Time.
- Under Windows Device Manager → Port → USB Serial Port (right mouse click) → properties → Port Setting → Advanced → Latency Timer (msec) → set to 1msec.

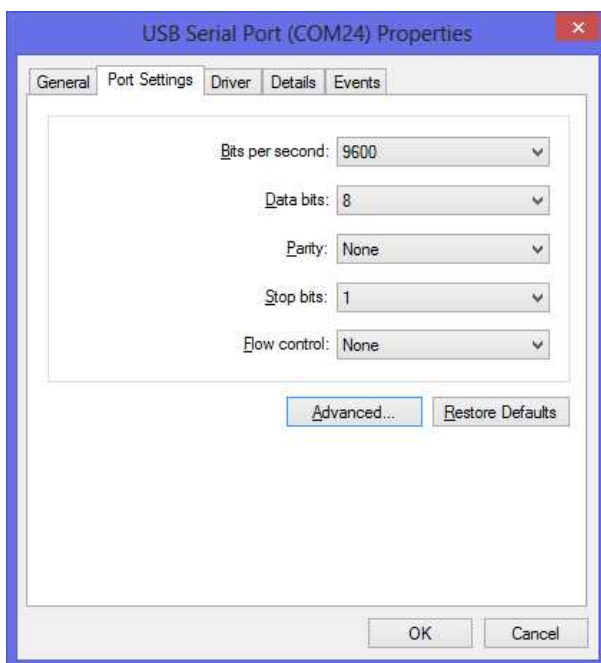
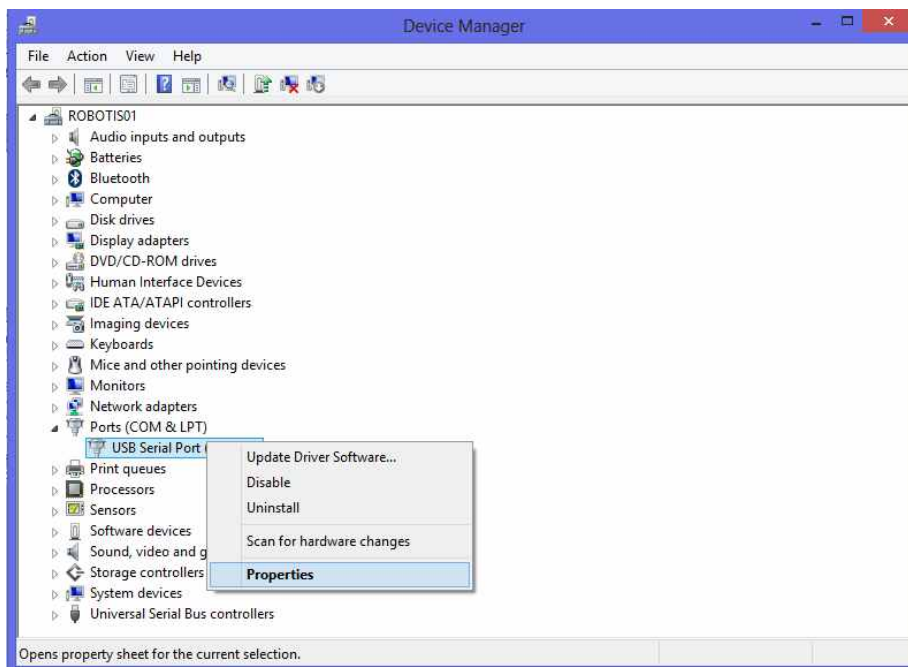

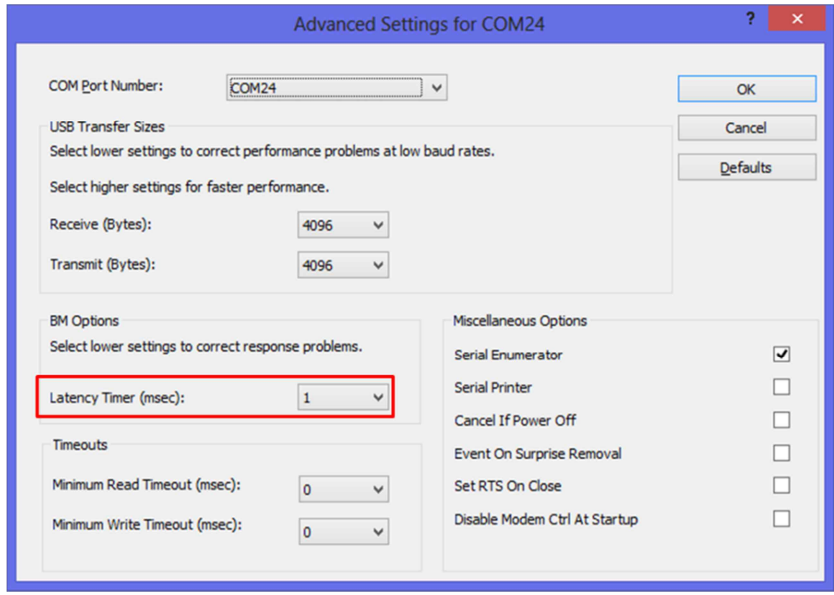

- Click "Ok" to confirm.

1.1.2 Dynamixel Wizard

i. Operating a Dynamixel PRO

- Supply 24V power to Dynamixel PRO once the wiring is complete. For safety, finish connecting the wires before supplying the power.
- Open RoboPlus to run Dynamixel Wizard.
- Select a COM Port that refers to the connection of USB-to-Dynamixel dongle to your PC and click  button to connect to USB-to-Dynamixel.

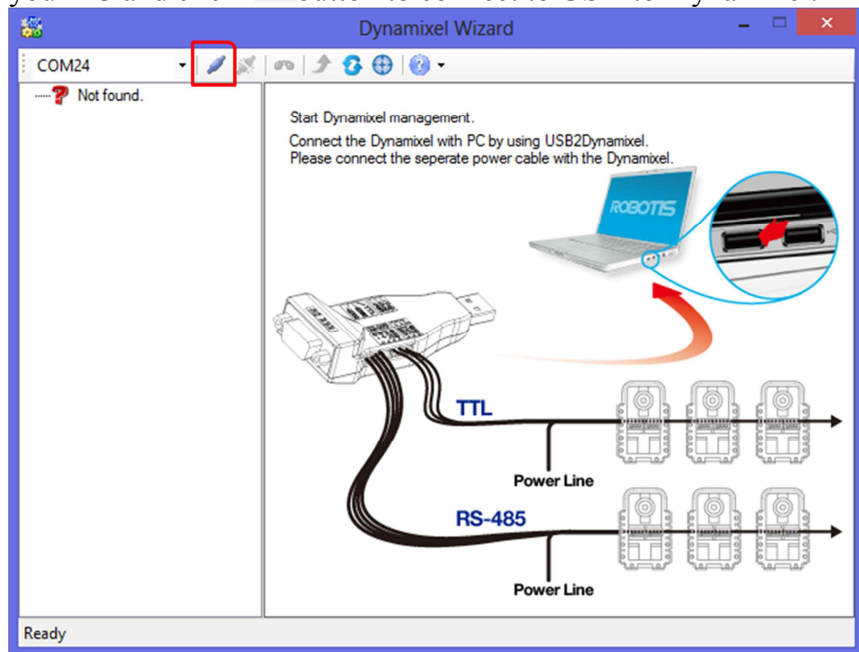

- Once the port is connected, select 'DXL 2.0' and '57600,' then click 'Start Searching.' Dynamixel PRO's Default ID setting is 1 and baud rate of 57600 bps.

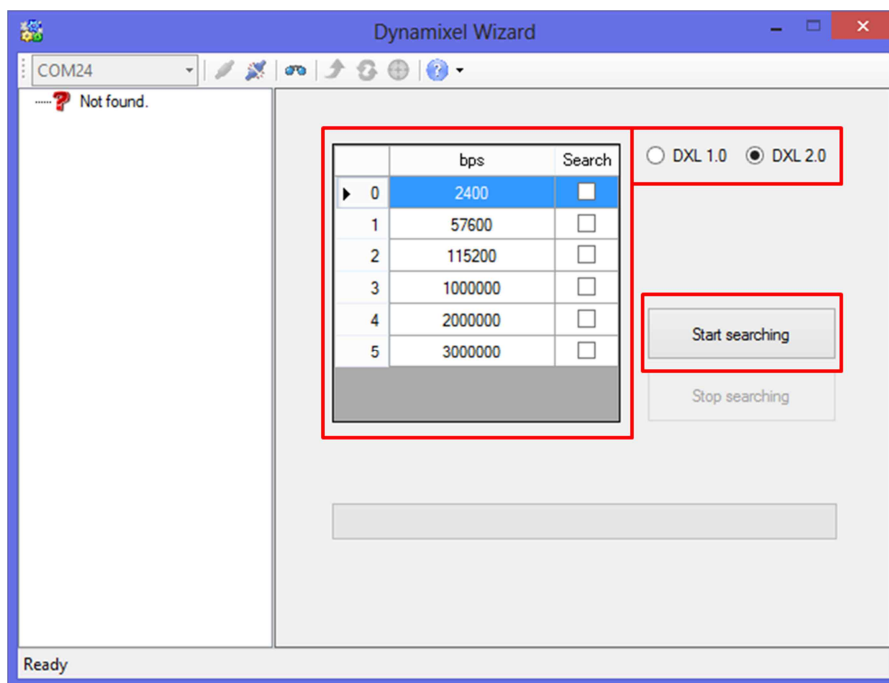

- Select the Dynamixel PRO that has been found on the left hand side.

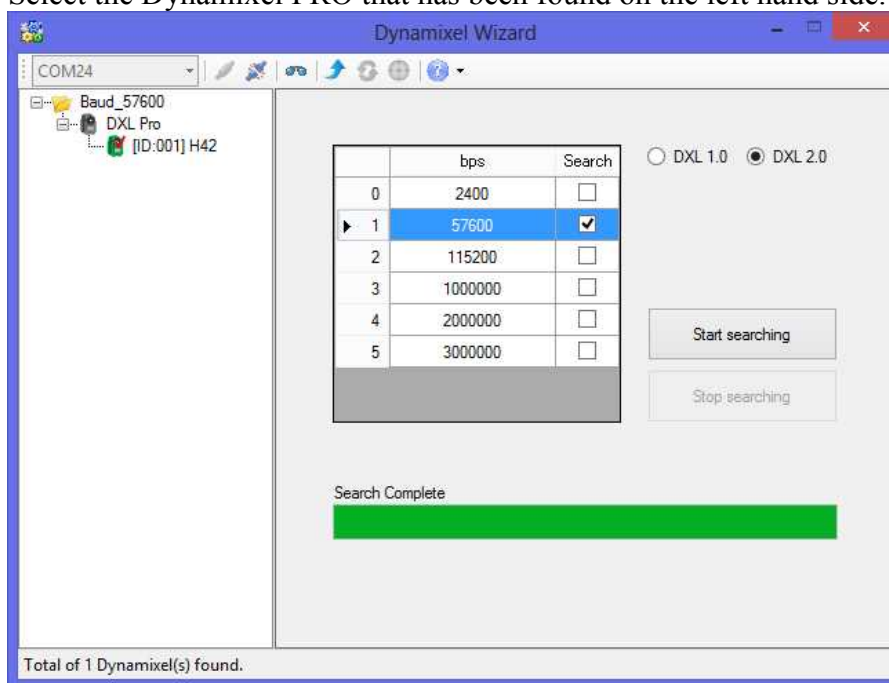

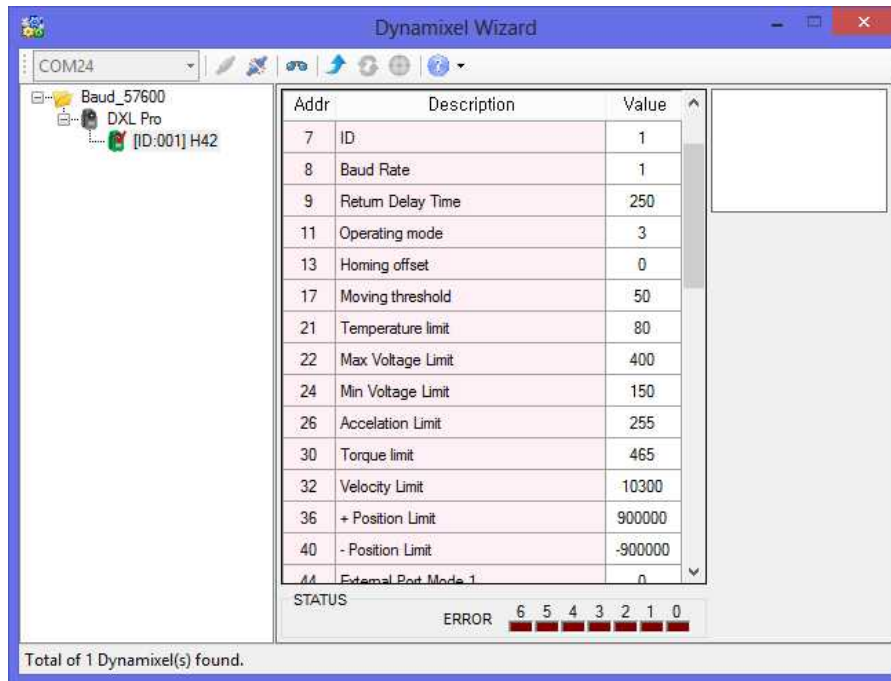

- Unlike other Dynamixel models, Dynamixel PRO is only drivable when torque is enabled. Therefore, torque must be enabled before driving Dynamixel PRO.
- Scroll down the middle table on Dynamixel PRO Wizard and locate Torque Enable (#562).

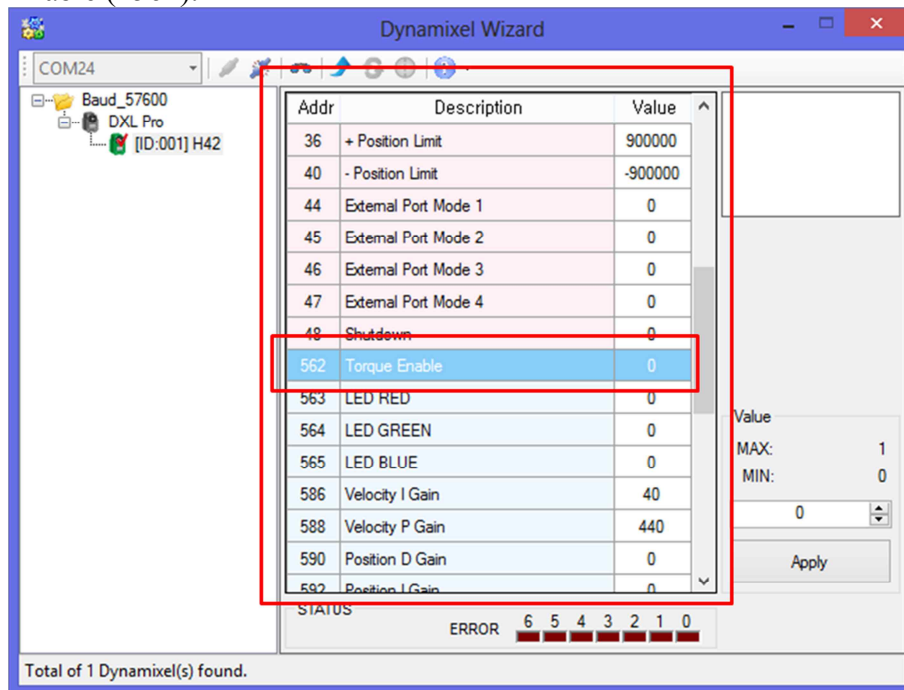

- Change the value on the lower right hand corner to '1' and click 'Apply.'

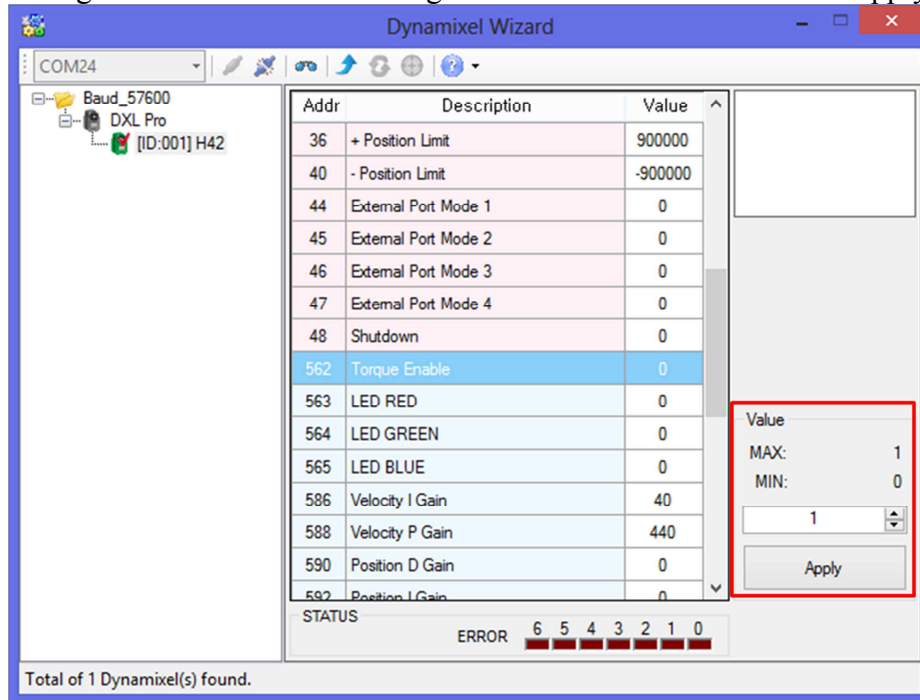

- Confirm that the 'Torque Enable' value is 1 and click Goal Position (#596).

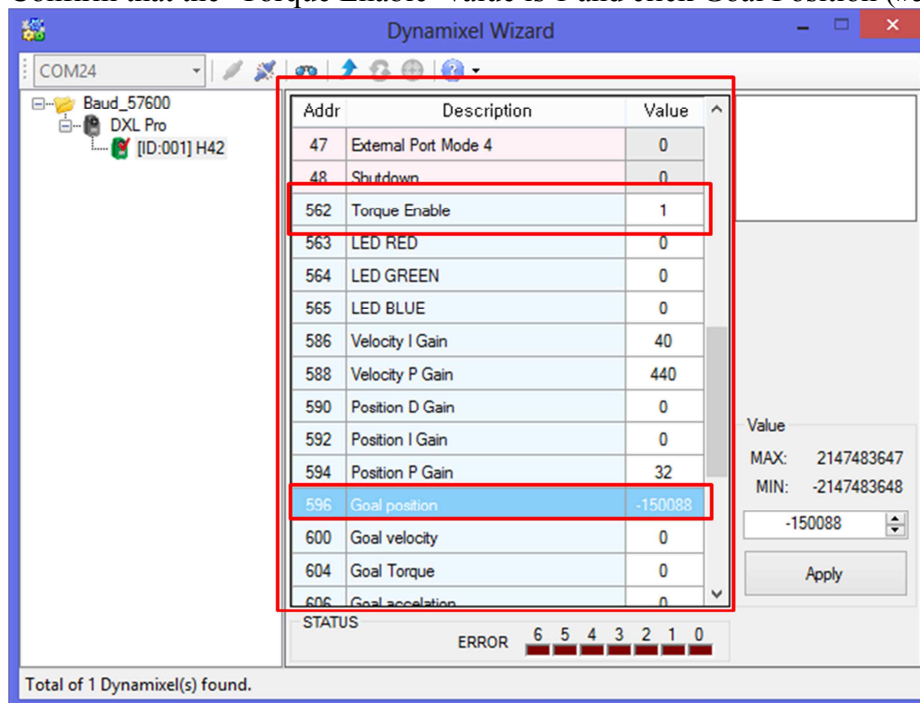

- Change the value of Goal Position on the lower right hand corner with an appropriate value and click 'Apply'. Check each Dynamixel PRO's Min and Max Position Limits (lower and upper "soft" limits).

by default Dynamixel PRO 54 series: -251000 ~ 251000 and Dynamixel PRO 42 series: -151875 ~ 151875.

- Visually verify position of Dynamixel PRO after clicking on 'Apply.'

- If Dynamixel PRO does not move, check to see if the Torque Enable value is 1. If the value is not set to '1' change the value and try again.
- Change the Goal Position value and click 'Apply.' Visually check Dynamixel PRO's position.
- The relationship between the Goal Position value and degree of rotation is shown below.

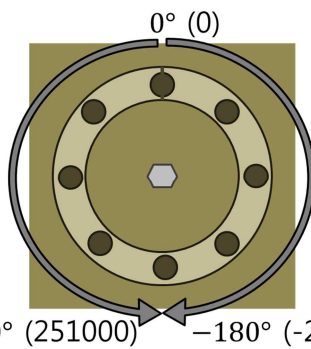
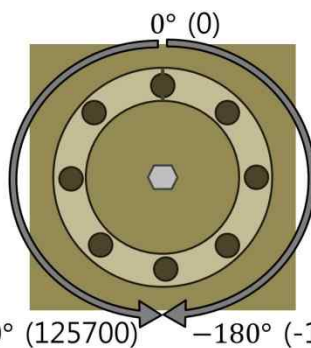
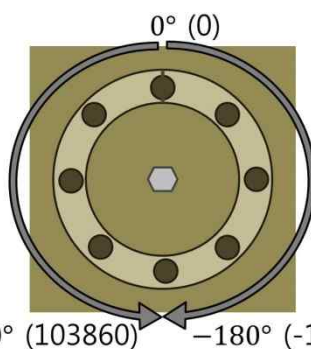
Model	Relationship between angle(deg) and position value
<p>H54-200-S500-R H54-100-S500-R</p>	<p style="text-align: center;">-180 ~ 180 (deg) → -251000 ~ 251000</p> <div style="text-align: center;">  <p>0° (0) 180° (251000) -180° (-251000)</p> </div> <p style="text-align: center;">$Goal\ Angle\ (deg) = Goal\ Position\ Value \times \frac{180^\circ}{251000}$</p>
<p>M54-60-S250-R M54-40-S250-R</p>	<p style="text-align: center;">-180 ~ 180 (deg) → -125700 ~ 125700</p> <div style="text-align: center;">  <p>0° (0) 180° (125700) -180° (-125700)</p> </div> <p style="text-align: center;">$Goal\ Angle\ (deg) = Goal\ Position\ Value \times \frac{180^\circ}{125700}$</p>
<p>L54-50-S290-R</p>	<p style="text-align: center;">-180 ~ 180 (deg) → -103860 ~ 103860</p> <div style="text-align: center;">  <p>0° (0) 180° (103860) -180° (-103860)</p> </div>

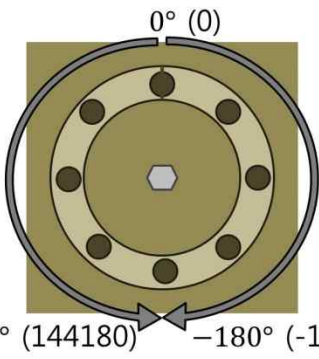
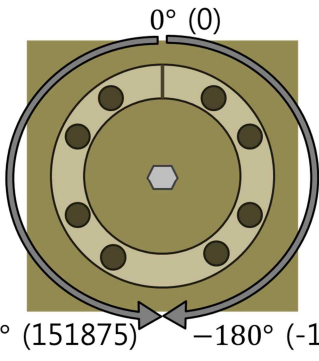
	$Goal\ Angle\ (deg) = Goal\ Position\ Value \times \frac{180^\circ}{103860}$
L54-30-S400-R	<p>-180 ~ 180 (deg) → -144180 ~ 144180</p>  <p>0° (0)</p> <p>180° (144180) -180° (-144180)</p> $Goal\ Angle\ (deg) = Goal\ Position\ Value \times \frac{180^\circ}{144180}$
H42-20-S300-R	<p>-180 ~ 180 (deg) → -151875 ~ 151875</p>  <p>0° (0)</p> <p>180° (151875) -180° (-151875)</p> $Goal\ Angle\ (deg) = Goal\ Position\ Value \times \frac{180^\circ}{151875}$

ii. Operating Dynamixel PRO in Wheel Mode

- There are 3 Modes in with Dynamixel PRO (Joint Mode, Wheel Mode, and Torque Mode).
- On Dynamixel Wizard, locate and click ‘Operating Mode’ (#11).
- When Torque Enable (#562) is turned ‘On’, the Operating Mode cannot be modified (left image below). The Operating Modes can be modified once the Torque Enable is turned ‘Off’ by setting it to 0. (right image below)

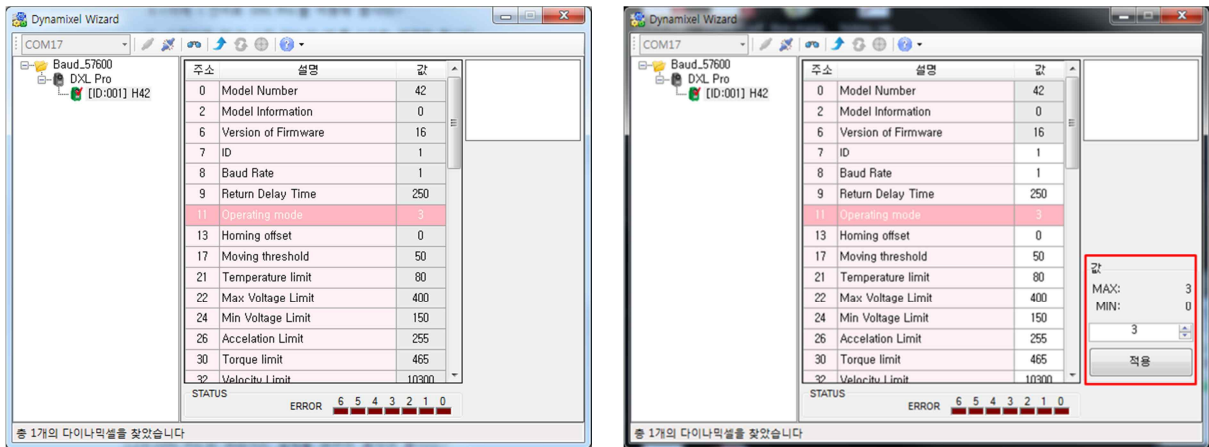

- Operating Mode (#11) settings are described below.

Operating Mode	Value	Description
Joint Mode	3	Controls the velocity and position of the servo. 1. Can move to the desired position at a desired velocity. 2. Can move using self-assigned trapezoidal Velocity Profile.
Wheel Mode	1	Controls the velocity of the servo. 1. Can rotate the servo at a desired velocity. 2. Can move using self-assigned trapezoidal Velocity Profile. 3. Cannot control the position of the servo.
Torque Mode	0	Controls the torque of the servo. 1. Cannot control velocity and position. 2. Only controls the output torque. 3. Since position and velocity control are not possible, the performance is similar to Wheel Mode.

- Note: use the reference above to set Dynamixel PRO to an appropriate mode.
- Set Torque Enable value as 0 and Operating Mode as 1, then click ‘Apply.’

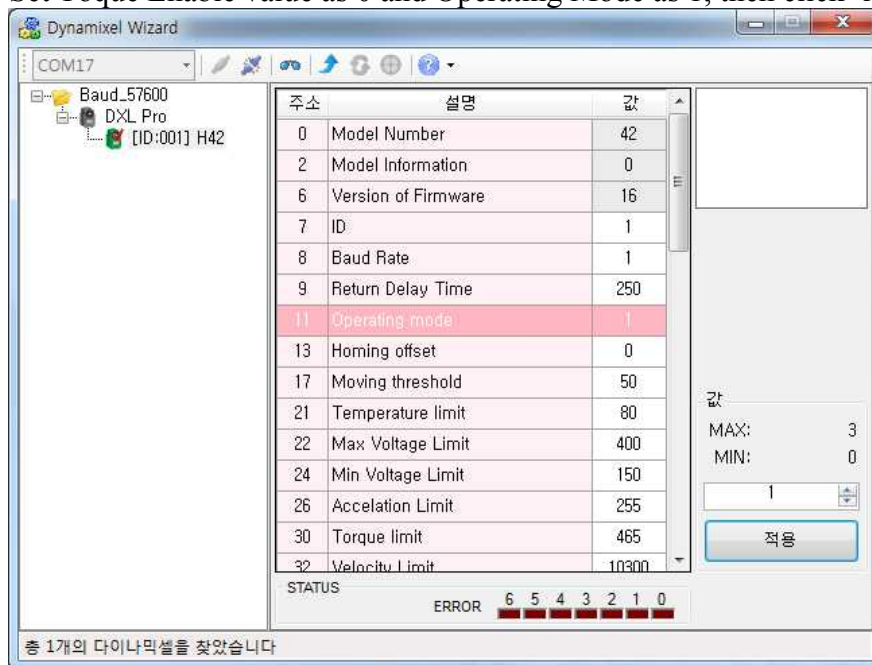

- Next, set Torque Enable (#562) as 1 and click ‘Apply.’
※ Torque Enable value on Dynamixel PRO series MUST be 1 to be activated.
- On the Table, set Goal Velocity (#600) as 1000 and click ‘Apply.’

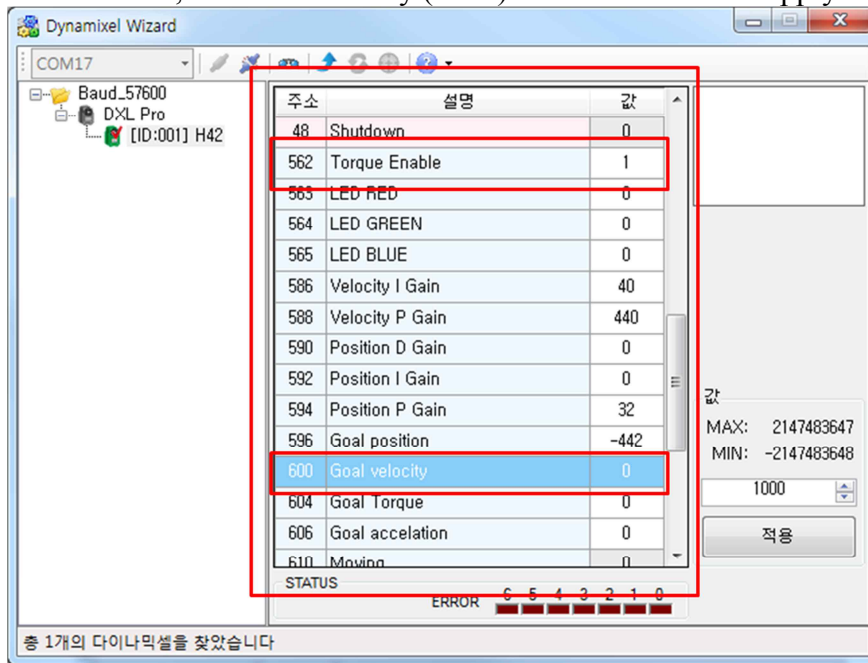

- Visually check for Dynamixel PRO rotate slowly in counter-clockwise direction.
- If Dynamixel PRO does not rotate, check if Torque Enable is set to 1.
- Set Goal Velocity (#600) to -1000 then click on ‘Apply.’ Visually check for Dynamixel PRO rotate slowly in clockwise direction.
- Set Goal Velocity as 0 and Dynamixel PRO stops moving.
- Try changing the Goal Velocity value as 3000, 10000, 15000, -3000, -10000, -15000, 0, etc... and observe the changes in rotation.
- The relationship between Goal Velocity (#600) values and rpm is as follows:

Sign of Value	Rotating Direction	RPM (@ 20V minimum)
+	CCW	$\frac{\text{Magnitude of Value}}{\text{Gear Reduction Ratio}}$
-	CW	

※ Notice 1

- If Torque Enable(#562) on the Table is set as 1, it means Dynamixel PRO is ready to operate. This is called the **Torque On** state.
- If Torque Enable(#562) on the Table is set as 0, it means Dynamixel PRO is unable to operate. This is called the **Torque Off** state.

※ Notice 2

- The Table in the middle of the Dynamixel Wizard is called the Control Table.
- Control Table includes the list of functions that is used to control a Dynamixel

- Dynamixel PRO movements and settings can be adjusted by inputting the appropriate values on the address.
- For example, on Control Table, the values on Torque Enable (#562) can be changed to 0 or 1 to turn torque. Also, appropriate values can be entered into Goal Velocity (#600) to rotate in desired velocity.

※ Notice 3

- The values that are 'locked' on the Control Table when the Torque Mode is on, is referred as the EEPROM domain (non-volatile).
- The values that are written on the EEPROM area are preserved even if the Dynamixel PRO is turned on/off. The value cannot be modified when the torque is on, and the torque needs to be off to modify the EEPROM area values.
- EEPROM area is indicated as pink on Dynamixel Wizard.
- The section that is indicated as blue on the Control Table, such as Goal Velocity, is called the RAM domain (volatile).
- The values on the RAM domain are lost when Dynamixel PRO is turned off. The values can be changed regardless of the torque on/off setting.

iii. LED Control of Dynamixel PRO

- Unlike other Dynamixels, Dynamixel PRO has 3 color LEDs.
- Therefore, LEDs can be set to emit multiple colors.
- Try clicking the LED RED.

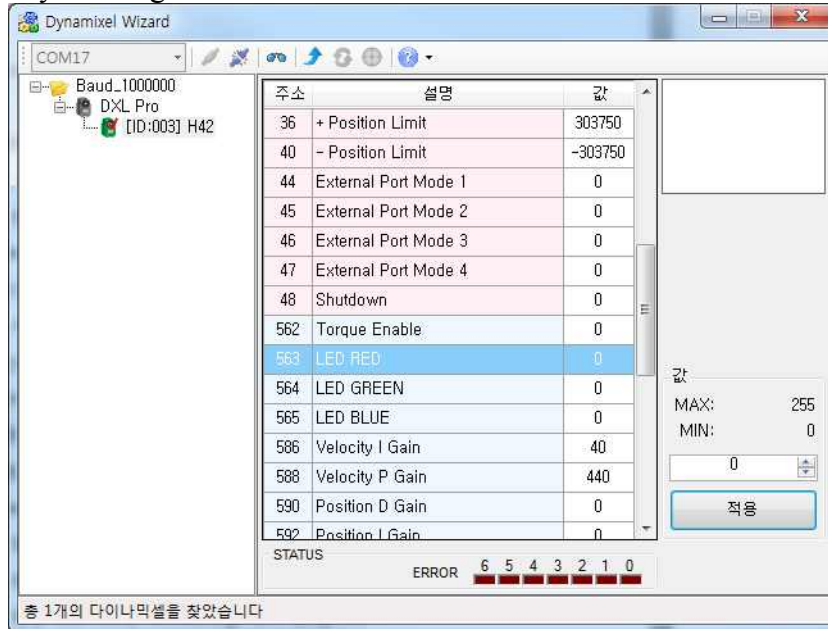

- Input 255 under LED RED value and click 'Apply'. The red LED should turn on.
- The intensity of the LED emission can be adjusted by changing the values between 0-255.
- Try changing the values of the LED RED, LED GREEN, and LED BLUE to observe the change in colors.



iv. ID configuration

- Individual ID is required for communication when when multiple Dynamixel PROs are linked together.
- For example, a single Dynamixel PRO can be driven via its ID even when 3 Dynamixel PROs are linked together.
- A problem may occur if more than one Dynamixel with the same ID are linked together.
- #7 on the Control Table of the Dynamixel Wizard is the value for ID.
- **ID is a part of the EEPROM area on the Control Table. Be sure to check if Dynamixel PRO torque is Off before changing the ID.**

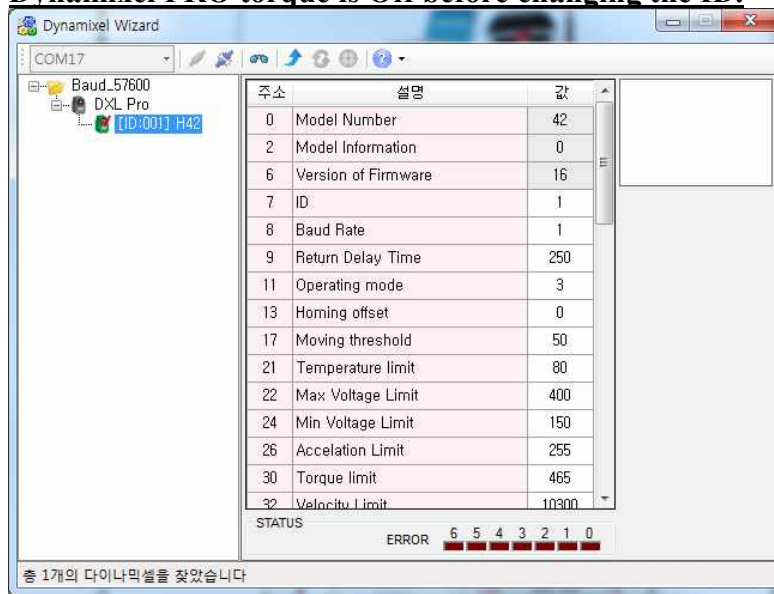

- Once changes are made to ID (#7) value to 3; click on ‘Apply.’ The change of value can be observed on the left table.

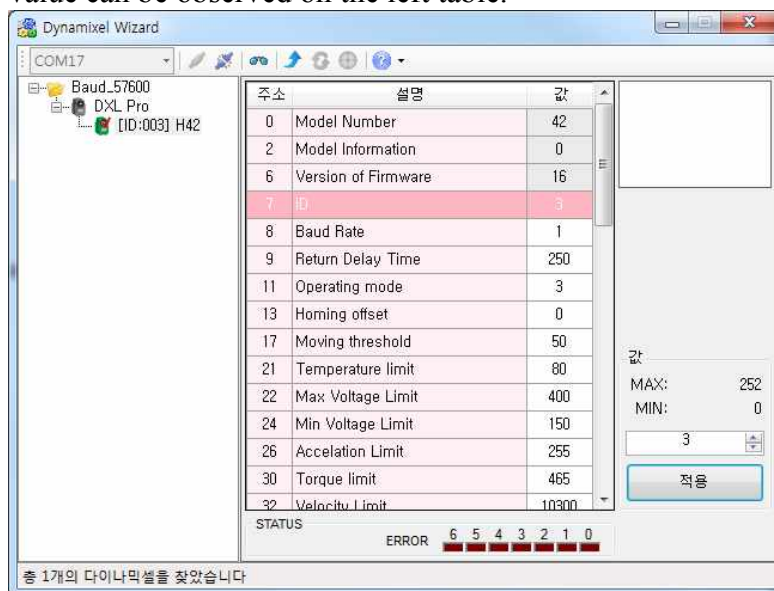

- If the Dynamixel PRO ID cannot be changed, make sure the Torque Enable is turned off.

v. Modifying the baud rate.

- #8 on the Control Table of the Dynamixel Wizard is the baud rate.
- **Baud rate is a part of the EEPROM area on the Control Table. Be sure to check if Dynamixel PRO torque is off before changing the baud rate.**
- Set the baud rate value as 3 then click ‘Apply.’

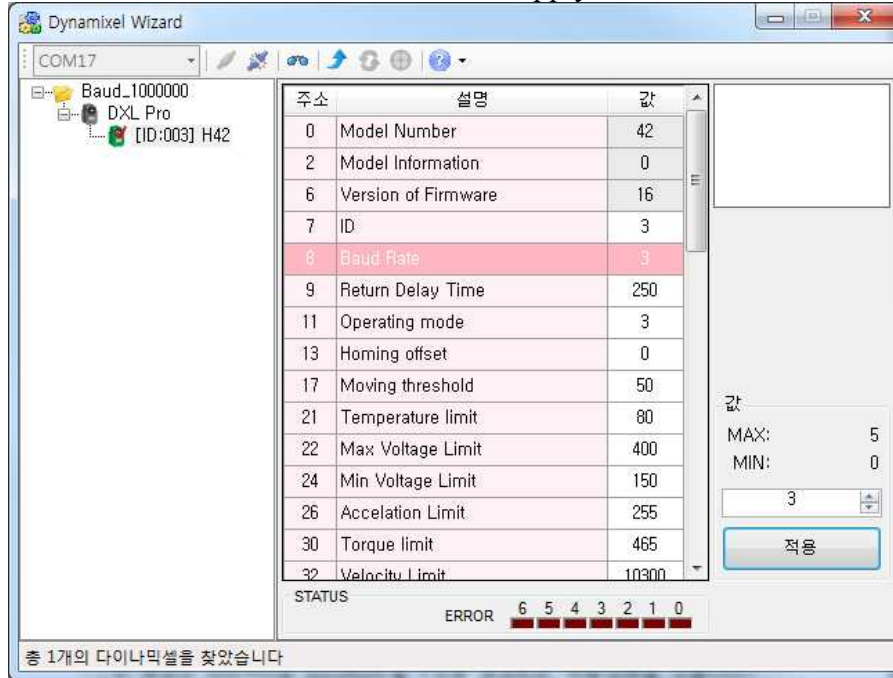

- Notice the change in baud rate to 1Mbps.
- If the baud rate cannot be modified check if Dynamixel PRO Torque Enable is turned on.
- Dynamixel PRO’s baud rate and Control Table values are as follows:

Value of Control Table	Baud Rate(bps: bit for seconds)
0	2400 bps
1	57600 bps
2	115200 bps
3	1 Mbps
4	2Mbps
5	3Mbps
6	4Mbps
7	4.5Mbps
8	10.5Mbps

- **※ When using a USB-to-Dynamixel dongle, Dynamixel PRO’s baud rate needs to be less than the USB-to-Dynamixel’s supported baud rate in current use.**

vi. Accelerating Dynamixel PRO in Joint Mode

- Verify if Dynamixel PRO is set as torque off status. If not, click on the Torque Enable (#562) on Control Table and set the value to 0. Click the ‘Apply’ to change it to torque off status.
- Modify the Operating Mode (#11) value as 3 then click ‘Apply’ to set Dynamixel PRO as Joint Mode.
- Set Goal Acceleration (#606) value as 4, then click ‘Apply.’

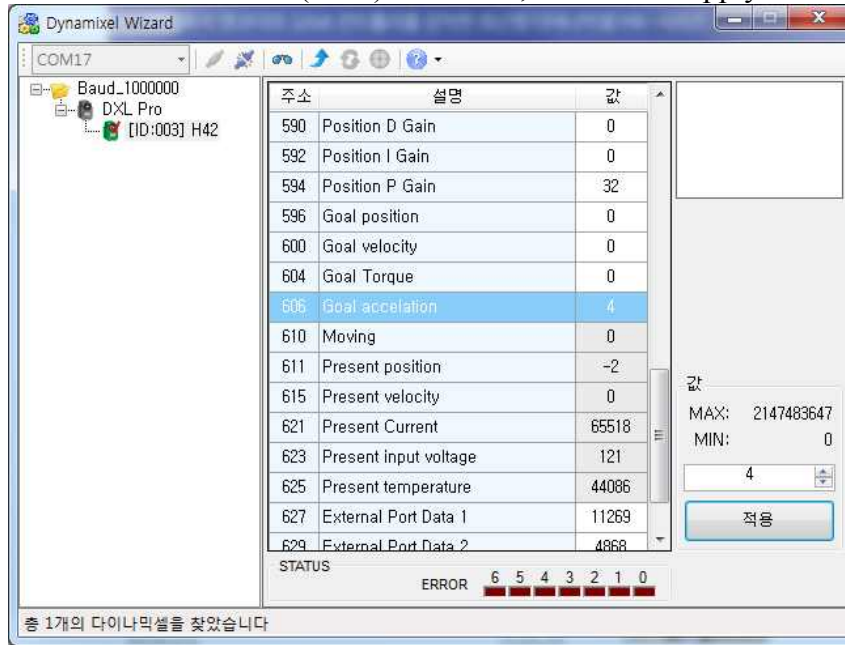

- Set Torque Enable (#562) value as 1 and click ‘Apply’ to change Dynamixel PRO to ‘Torque On’ status.
- Set the Goal Position (#596) value to 100,000 or -100,000, then click ‘Apply.’ Note the difference in the movement of Dynamixel PRO from the time the Goal Acceleration was set to 0.

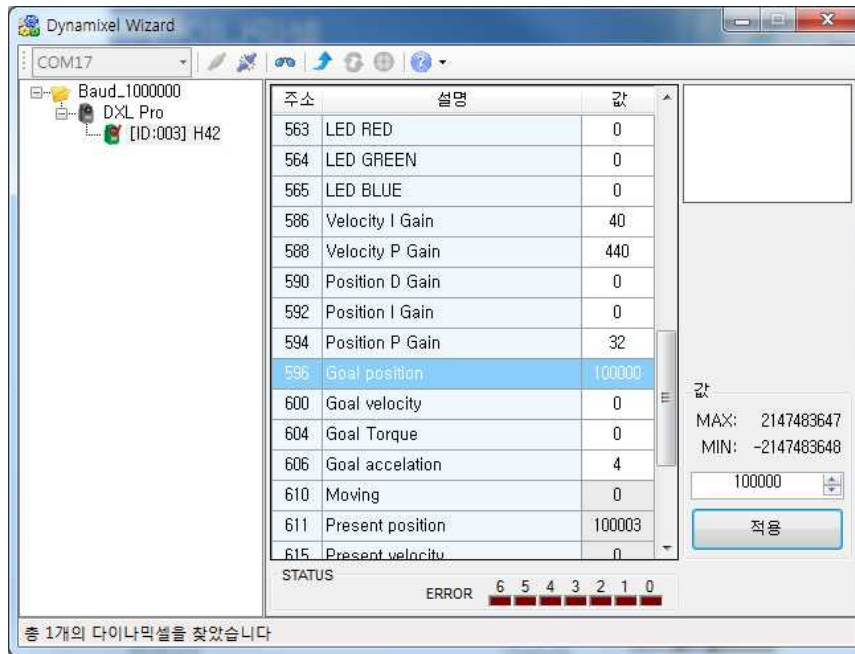

- If Dynamixel PRO cannot be driven check if Torque Enable is turned on.
- Also, if the Goal Acceleration movement does not differ from the input value, check if Goal Acceleration value is set to 4.
- If the Goal Acceleration value is not zero Dynamixel PRO will create a 'Trapezoidal Velocity Profile' (2.2 reference).
- Input random variables into Goal Acceleration and Goal Position to observe the different responses of Dynamixel PRO.

vii. Limiting the range of motion of Dynamixel PRO

- Set Dynamixel PRO to torque off status.
- Set +Position Limit (#36) value as 100,000 then click ‘Apply.’
- Set –Position Limit (#40) value as -100,000 then click ‘Apply.’

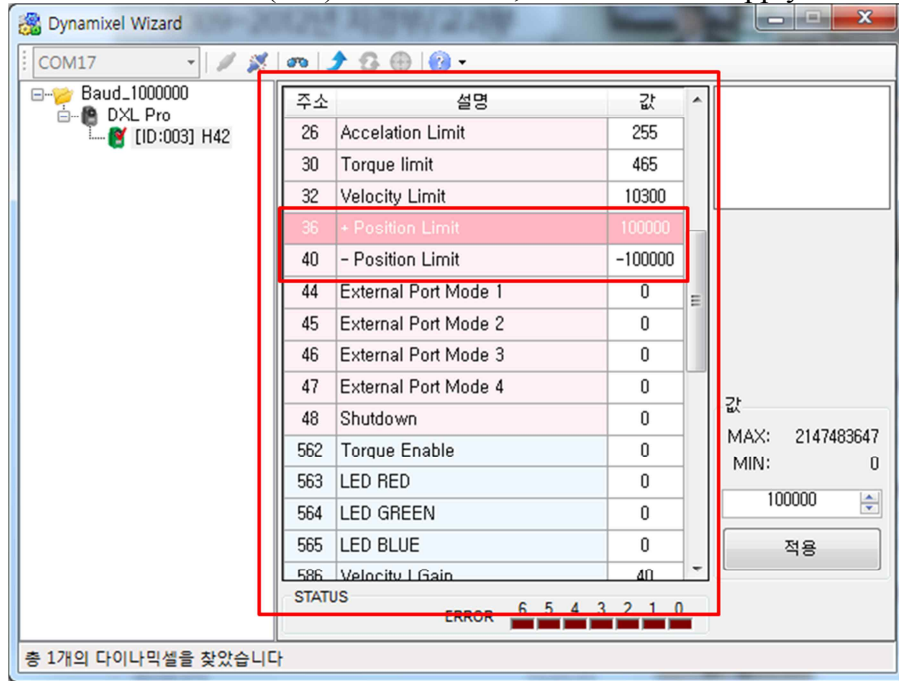

- **On the Control Table, +Position Limit (#36) and –Position Limit (#40) are a part of the EEPROM area.**
- **Therefore, if the values cannot be changed check if the Torque Enable is turned On.**
- If +Position Limitd and –Position Limit values can be modified it means Torque Enable is on.

- Once Torque Enable is on set Goal Position (#596) value as 150,000.

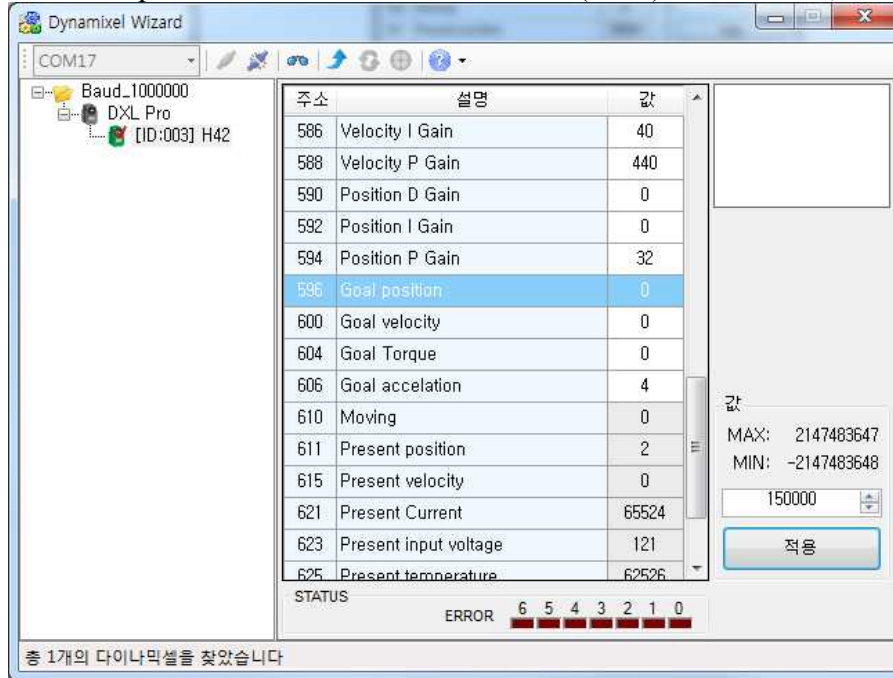

- Even though the Dynamixel PRO is in a torque on state, there is no response because the Position Limit value exceeds the set limit.
- If Dynamixel PRO is operational, check the +Position Limit value, and if the value is not 100,000, turn torque off. Input the +Position Limit value as 100,000 and click 'Apply,' then turn torqueOn.
- This time, set the Goal Position value as 100,000. Observe movement to position value '100,000.'
- Input the Goal Position value as -150,000 (there should be no movement). Try inputting -100,000 instead (Dynamixel PRO will move).
- Input random Goal Position values and click on 'Apply.' Position values will move within the "soft" limits.

viii. Extending the range of motion of Dynamixel PRO

- +Position Limit and –Position Limit restrict or extend Dynamixel PRO’s operation range.
- Turn off Torque Enable by changing the value to 0.
- On the Control Table, set +Position Limit (#36) value as 900,000 then click ‘Apply.’
- On the Control Table, set –Position Limit (#40) value as -900,000 then click ‘Apply.’

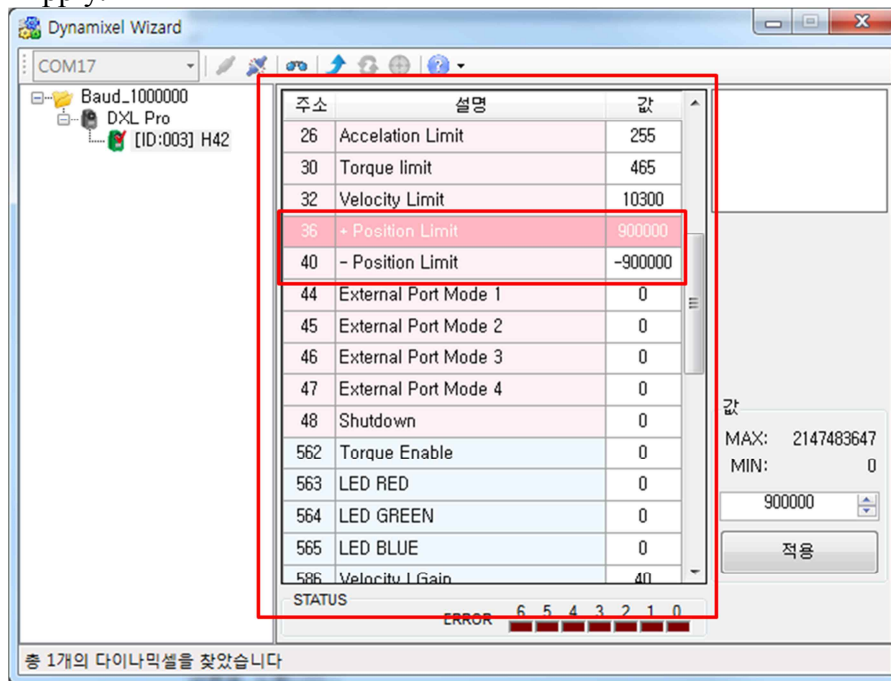

- **+Position Limit(#36) and –Position Limit(#40) on the Control Table are a part of EEPROM area.**
- **If the values cannot be changed, check if Torque Enable is on.**
- Change the +Position and –Position Limit values, and then turn Torque Enable on.

- Set the value of Goal Position (#596) as 900,000 while Enable Torque is on.

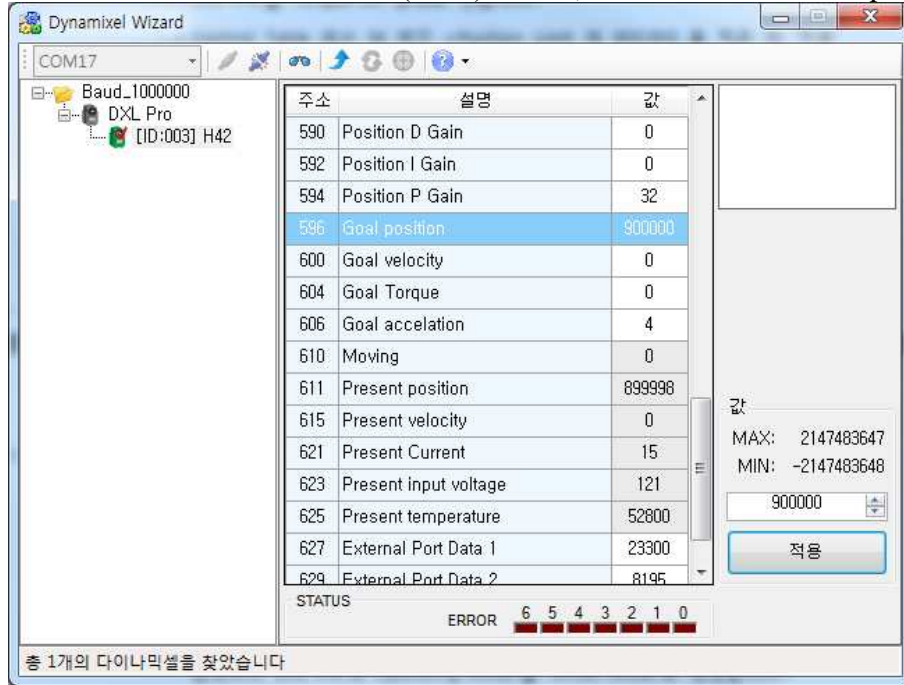

- Dynamixel PRO rotates more than 360 degrees to reach its goal position.
- If Dynamixel PRO is not responsive check the +Position Limit value. If the value is not 900,000 turn Torque Enable off. Change the +Position Limit value to 900,000 and click on 'Apply.' Turn Torque Enable back on.
- Set Goal Position as -900,000. Dynamixel PRO will rotate a couple of times in a counter-clockwise direction and stop at the designated position.
- Input random values into the Goal Position and click 'Apply.' Verify that Dynamixel PRO reaches the Goal Position.
- Please refer to 1.1.2.i. 'Relationship between angle (degrees) and position value.'

- ix. Accelerating Dynamixel PRO in Wheel Mode
- x. Refer to ‘1.1.2. ii ‘Operating Dynamixel PRO in Wheel Mode’
 - Set Goal Acceleration (#606) value as 4, and then click ‘Apply.’

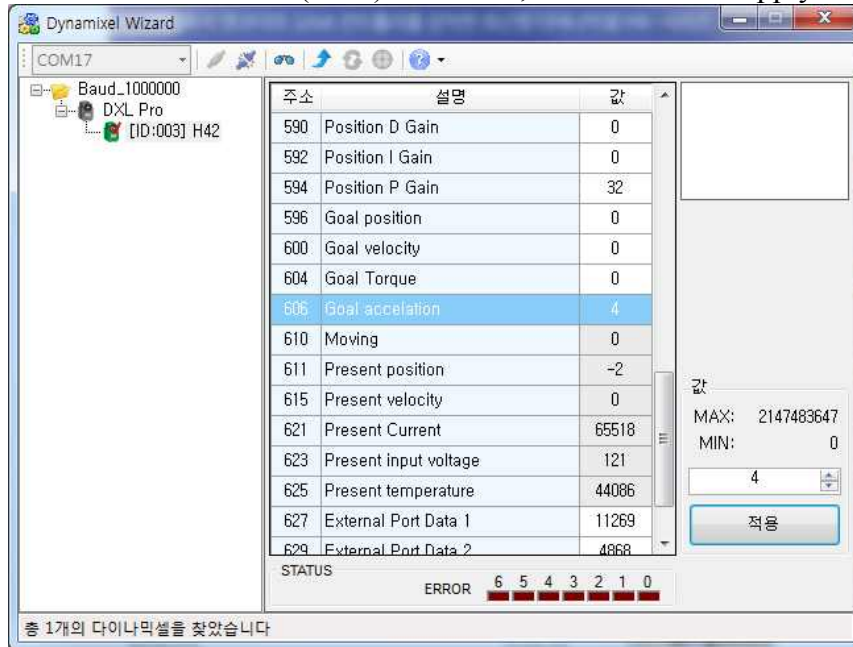

- Set Torque Enable (#562) as 1, and click ‘Apply’ to set Dynamixel PRO to torque on status.
- Set the Goal Velocity (#600) value to 5,000 or -5,000 and click ‘Apply.’ Compare the movement to the time when the Goal Acceleration value was set to 0.

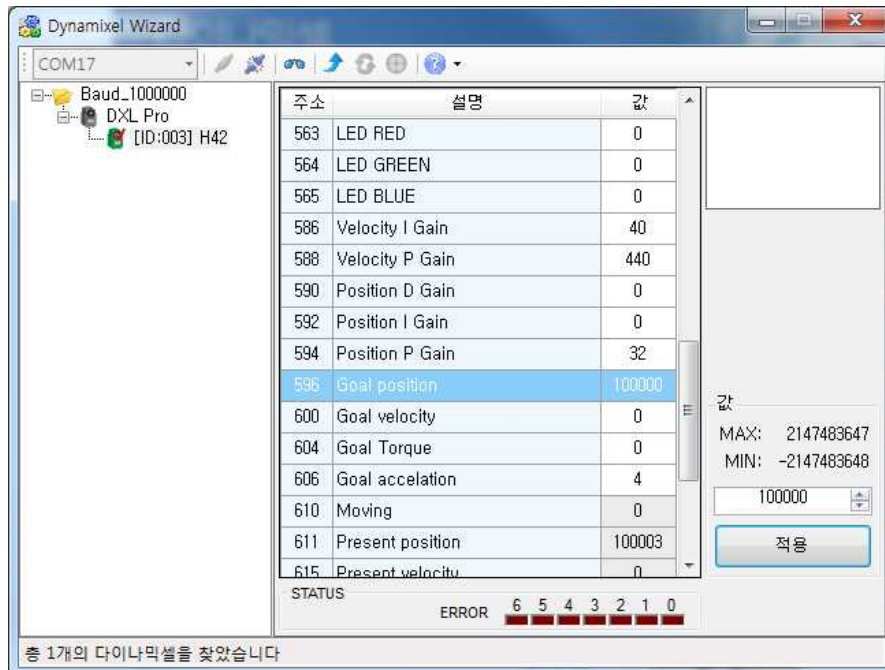

- If Dynamixel PRO does not move check if the Enable Torque value is 1.
- If the movement is no different than when the Goal Acceleration value was 0 check if the Goal Acceleration value is set to 4.

- If the Goal Acceleration value is not zero Dynamixel PRO will create a 'Trapezoidal Velocity Profile' (2.2 reference).
- Input random values into Goal Acceleration and Goal Position to observe the different responses of Dynamixel PRO.

xi. Torque Mode of Dynamixel PRO

- Set Dynamixel PRO to torque off condition and input the Operating Mode value as 0. Click on ‘Apply.’

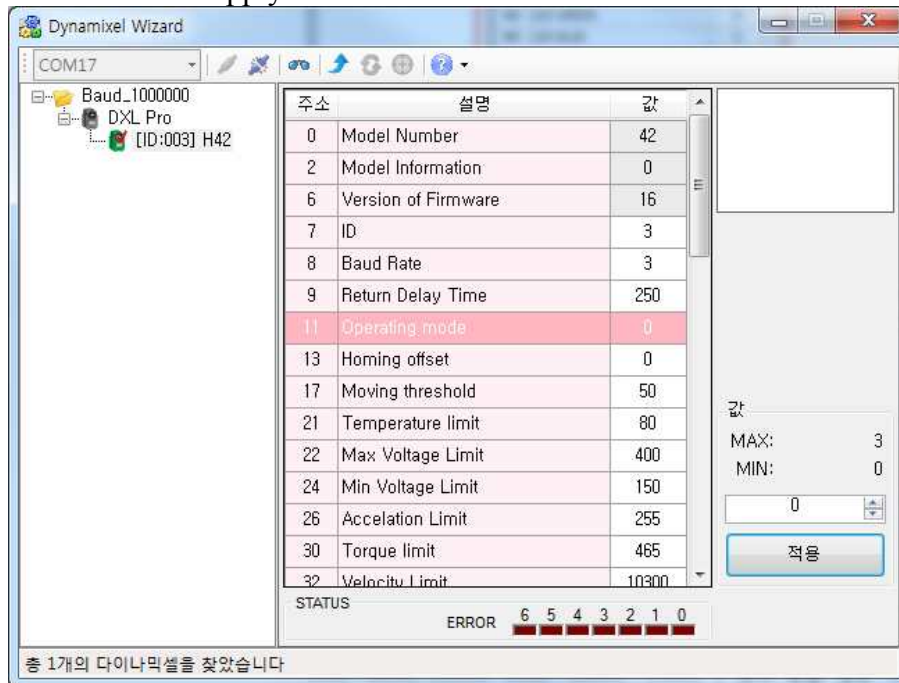

- Enable the torque by turning Torque Enable on.
- Set Goal Torque (#604) value as 100, and click ‘Apply’.

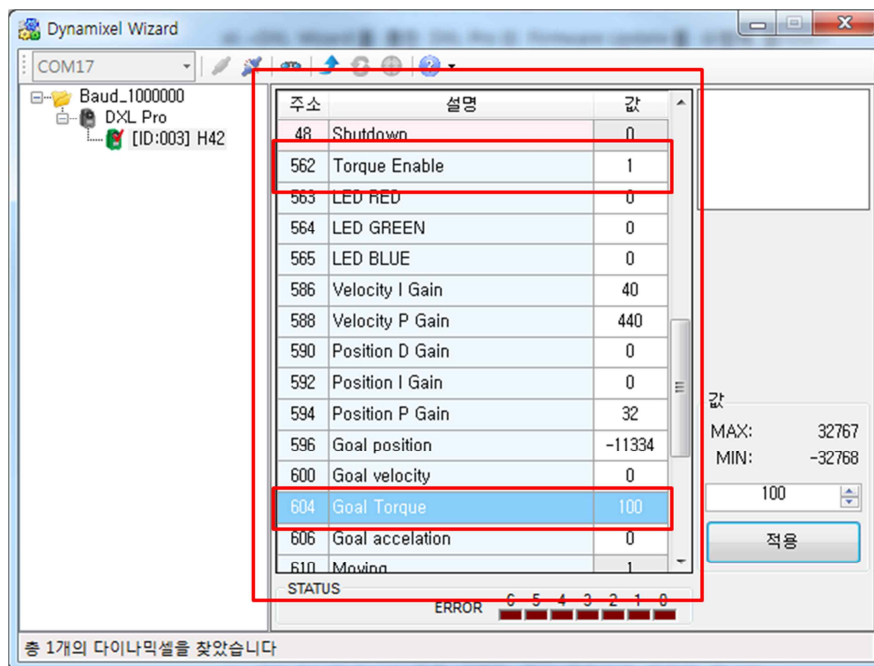

- Note the rotation of the Dynamixel PRO accelerating in the counter-clockwise direction.
- If Dynamixel PRO is not moving check if Dynamixel PRO is in torque off condition.

- Set the Goal Torque (#604) as -100 and click on ‘Apply.’
- Note the rotation of Dynamixel PRO accelerating in the clockwise direction.
- Set the Goal Velocity as 0 to stop rotation.
- Try inputting 30, 100, 400, -400, -100, -30, 0, etc... values into Goal Velocity and click on ‘Apply.’ Observe how the Dynamixel PRO responds.
- Goal Torque (#604) value controls the flow of current into Dynamixel PRO.
- The relationship between the Goal Torque value and the current is shown below. Please refer to Dynamixel PRO datasheet to see how current relates to torque.

Model	Relationship between goal torque and current
H54	$Current (mA) = goal\ torque\ value \times \frac{33000}{2048}$
H42	$Current (mA) = goal\ torque\ value \times \frac{8250}{2048}$

xii. Update Dynamixel PRO's firmware

- Firmware refers to code installed into Dynamixel PRO. This code is responsible for controlling Dynamixel PRO.
- Dynamixel Wizard connects to the internet and checks for the latest firmware
- When a new firmware for Dynamixel PRO is detected a red checkmark appears on the Dynamixel PRO icon (see illustrations below).

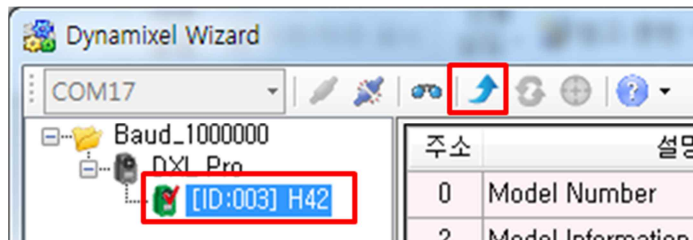

- **Only one Dynamixel PRO must be connected at a time during firmware update.**
- For firmware update select the correct Dynamixel PRO device and click the Firmware update button.
- Begin firmware update by following the instructions.
- Be sure to maintain all connections and power supply until update is finished.

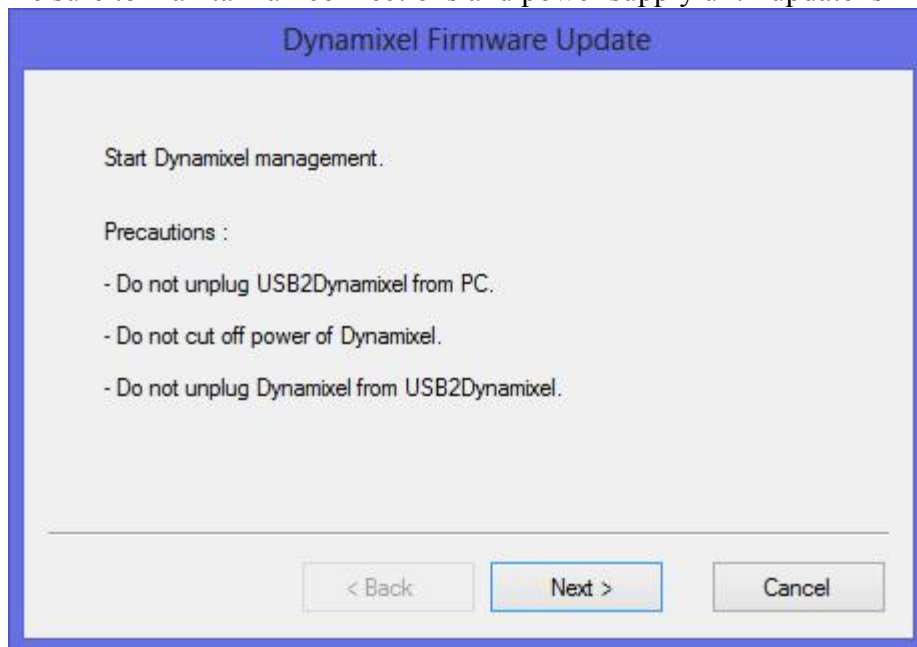

- The model number and firmware of the connected Dynamixel PRO can be verified.

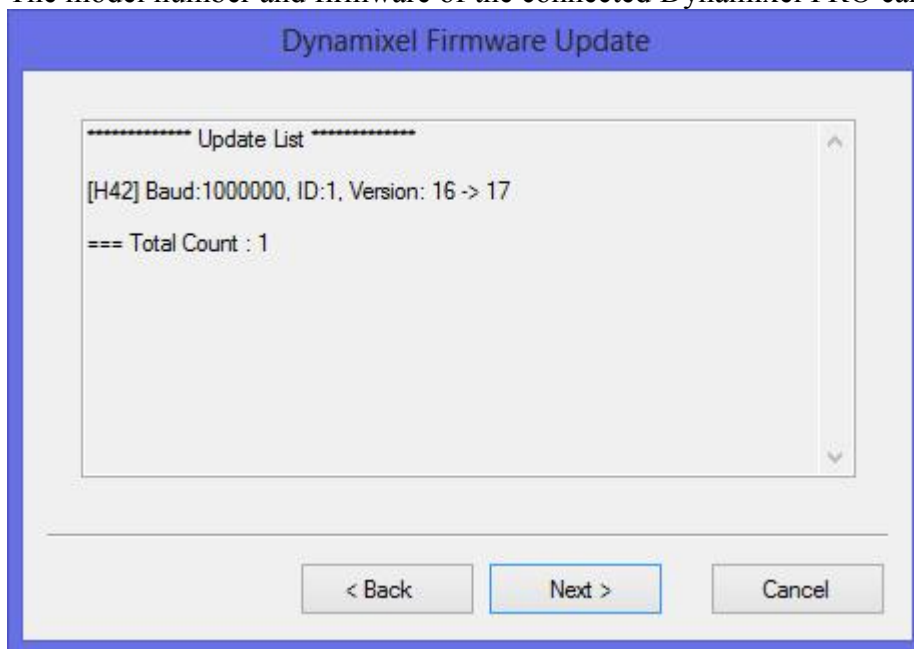

- Click on 'Next' to begin firmware update. Be sure to maintain all connections and power supply until the update is complete.

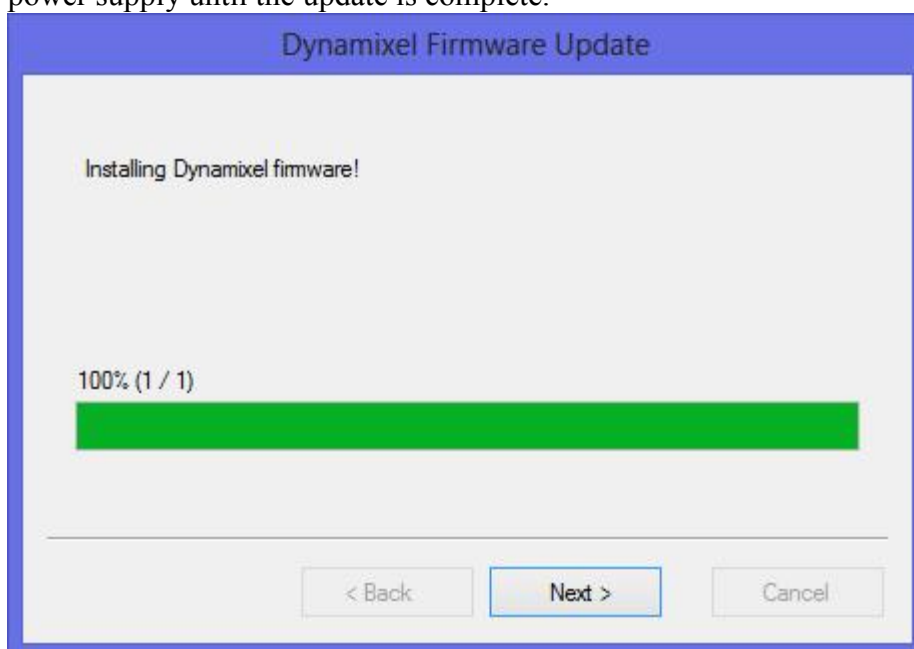

- Check Dynamixel PRO firmware update results.

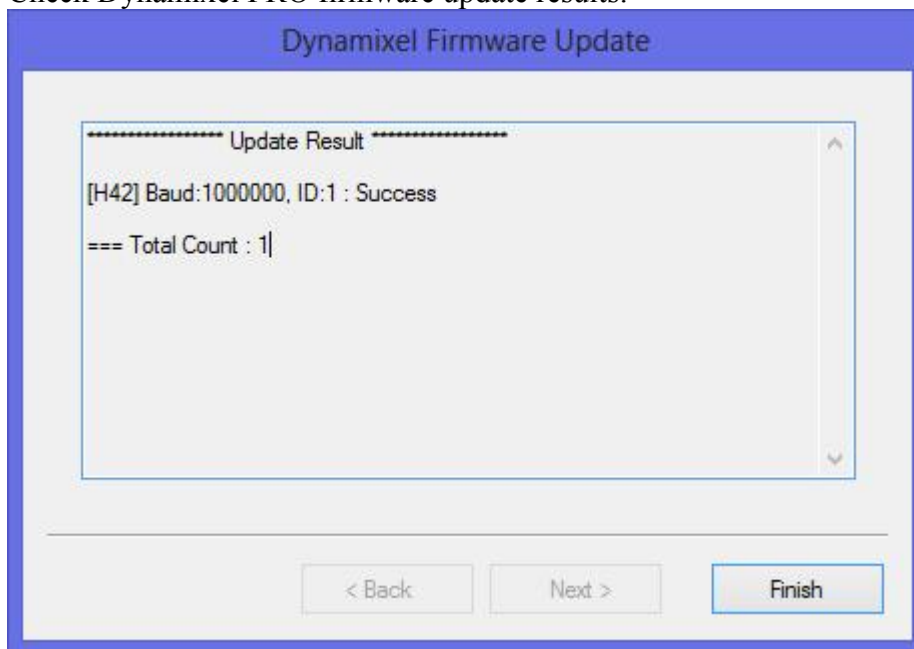

xiii. Dynamixel PRO Firmware Recovery with Dynamixel Wizard.

- Dynamixel Wizard can be used to recover the Dynamixel PRO's firmware if there is an issue.
- **※ When firmware is recovered, all the settings are set to default; therefore, the ID and baud rate must be checked. Be sure to have the USB-to-Dynamixel dongle properly set to the appropriate connector (RS-485).**
- **※ When recovering the firmware, Dynamixel PRO must be connected one at a time. Dynamixel PRO may malfunction if two or more Dynamixel PROs are daisy chained when recovering the firmware.**
- Begin Dynamixel PRO firmware recovery by clicking on the firmware recovery icon from the toolbar.
- Select that COM port number of the dongle to begin firmware recovery.



- Please read the instructions and begin Dynamixel PRO firmware recovery.



- Only one Dynamixel PRO must be linked to before initiating the Dynamixel firmware recovery.

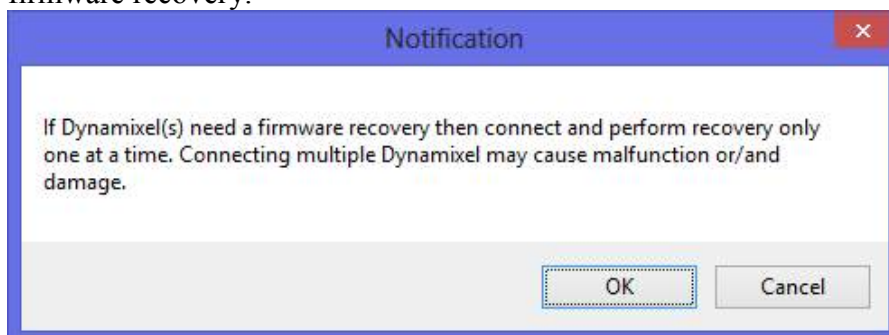

- Dynamixel PRO cannot be searched automatically because the firmware is not recognized. Therefore, you must set the Dynamixel PRO connected port manually. Since Dynamixel PRO cannot be recognized if the port is in use, finish other programs, and then continue the procedure.
- Select USB-to-Dynamixel-connected port and press "Search" button. Select the port the USB-to-Dynamixel dongle is connected to and click 'Search.'



- Turn off Dynamixel PRO then turn it back on to let the program detect Dynamixel PRO.



- If the Dynamixel PRO is not detected turn Dynamixel PRO off and on again.

- The screen will look like the following once Dynamixel PRO is detected.

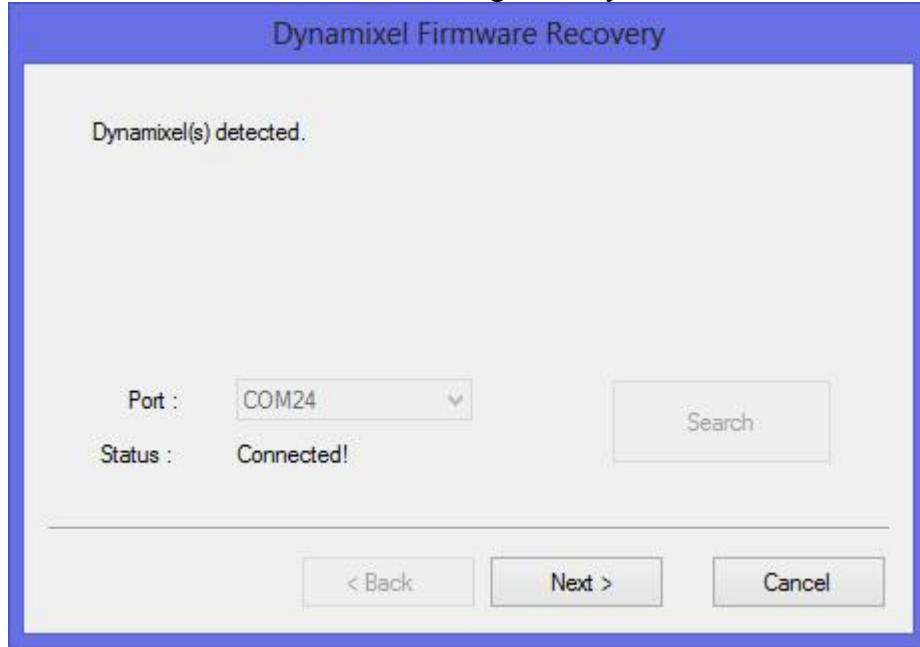

- Once Dynamixel PRO is detected downloadable information will appear. In Dynamixel PRO firmware recovery mode select the correct Dynamixel PRO version. Dynamixel PRO may malfunction if an incorrect firmware is downloaded.

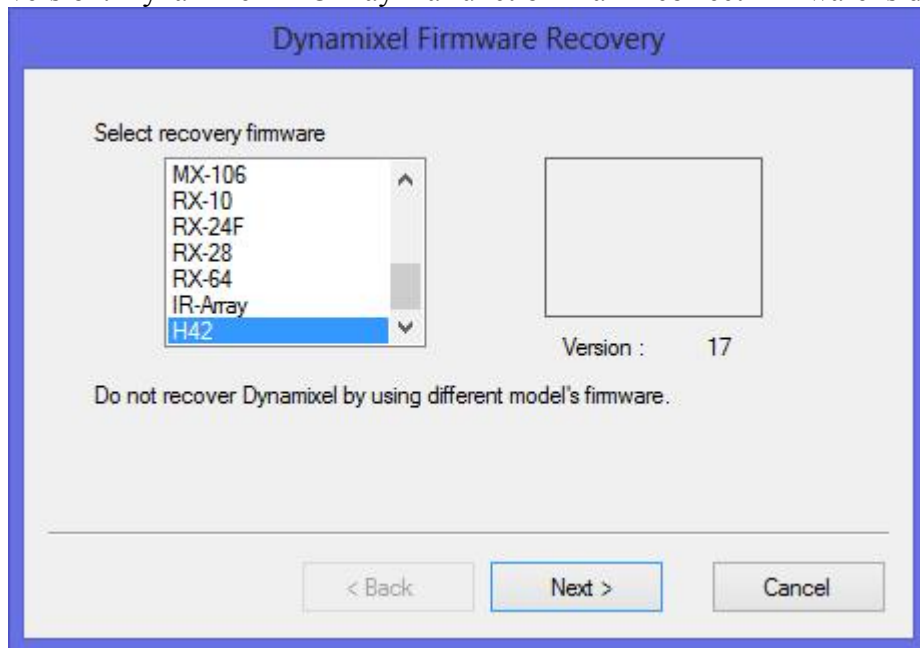

- Click on 'Next' to start firmware recovery. Be sure to maintain all connections and power supply until the recovery is complete.

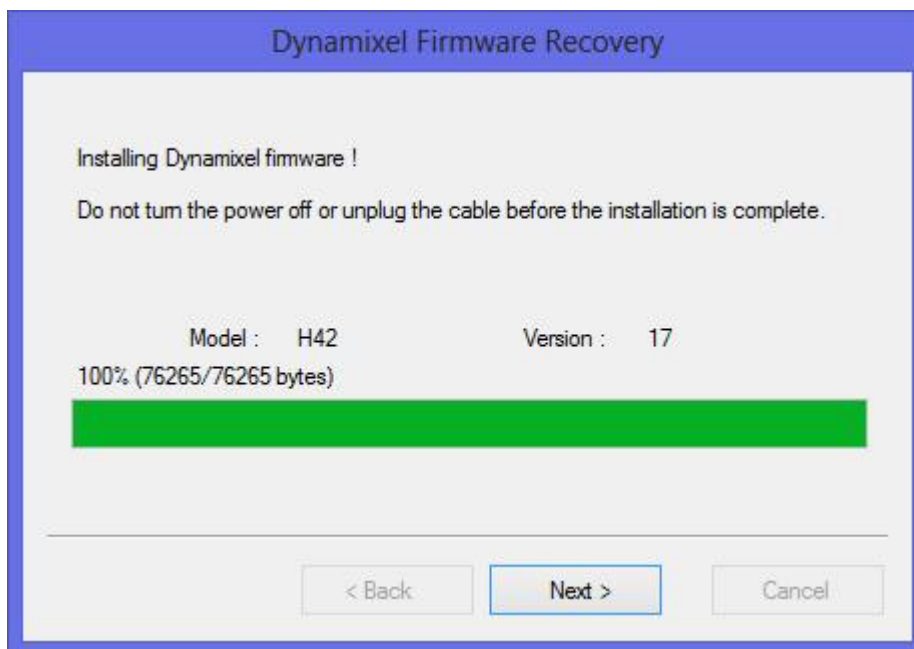

- Dynamixel PRO firmware recovery is complete.

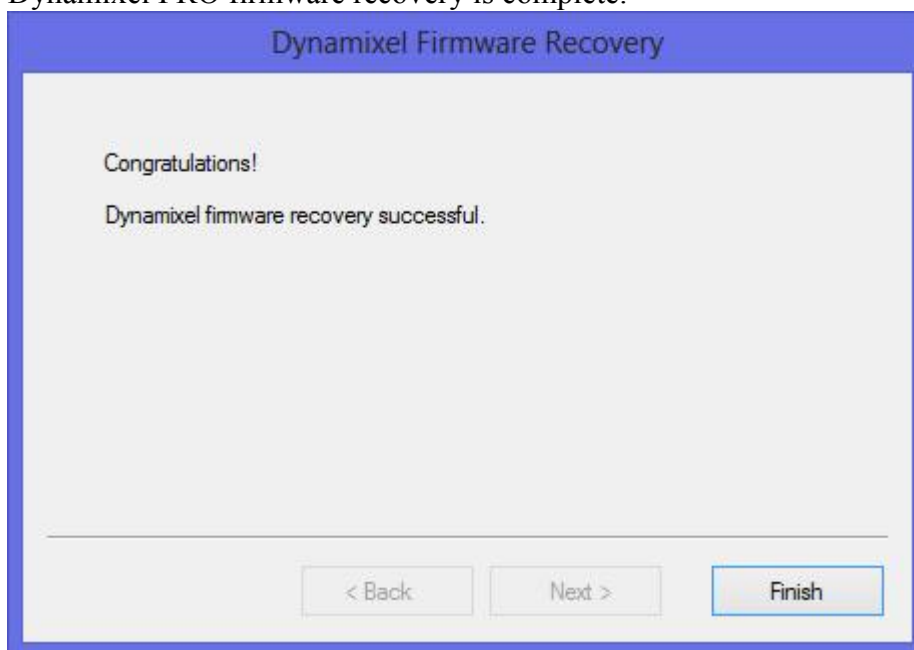

1.2 Visual Studio 2010

1.2.1 Preparation

i. Setting the development environment.

- For the following tutorial, prepare one Dynamixel PRO with an ID 1 and baud rate of 57600 bps.
- To familiarize the terminology used in the tutorial please go over the previous chapters.
- Find the Dynamixel SDK 2.0 for Windows with the included USB memory dongle.
- Extract the compressed file.

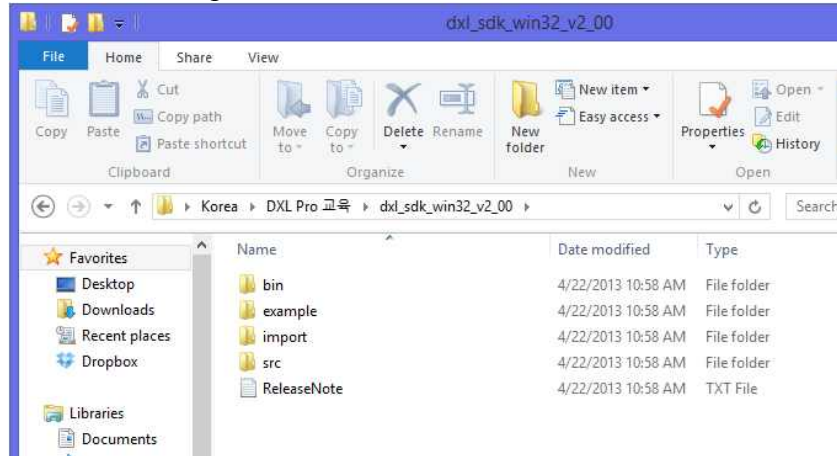

- Dynamixel SDK for Windows contains the following:
 - /bin** : DLL for Windows.
 - /import** : header and library files are located. (lib, h)
 - /src** : Contains DLL source code.
 - /example** : examples of various examples commonly used to control Dynamixel PRO.
- Properly set settings to use Dynamixel SDK in Visual Studio 2010.
- Create 'New Project' on Visual Studio 2010.
- In the 'Project Folder' you made, copy the following files are found inside the extracted SDK file: **bin/dynamixel.dll**, **/import/dynamixel.h**, **/import/dynamixel.lib**

- Go to project properties (see illustration below).

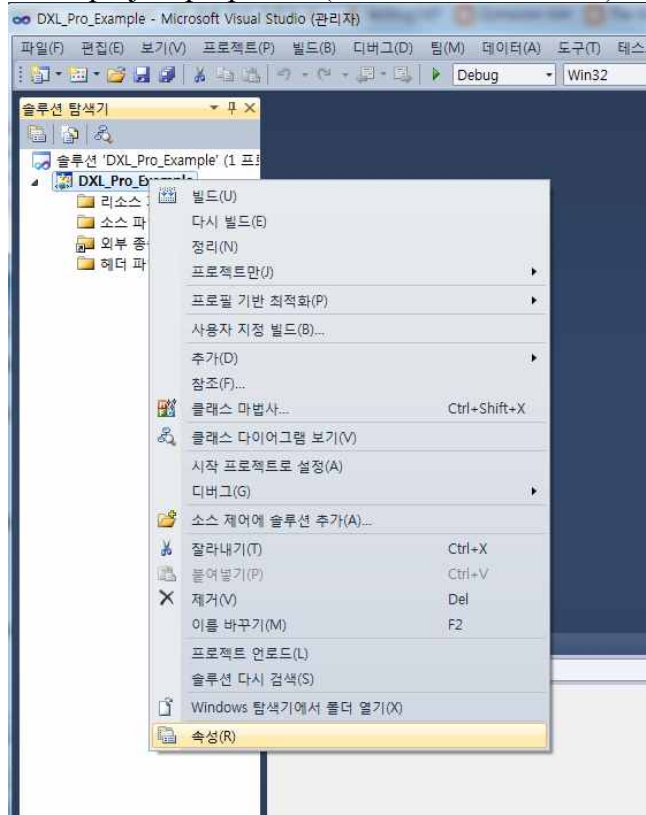

- On 'Properties', click 'Linker -> Input'.
- Click on the 'Additional Dependencies', then select 'Edit.'

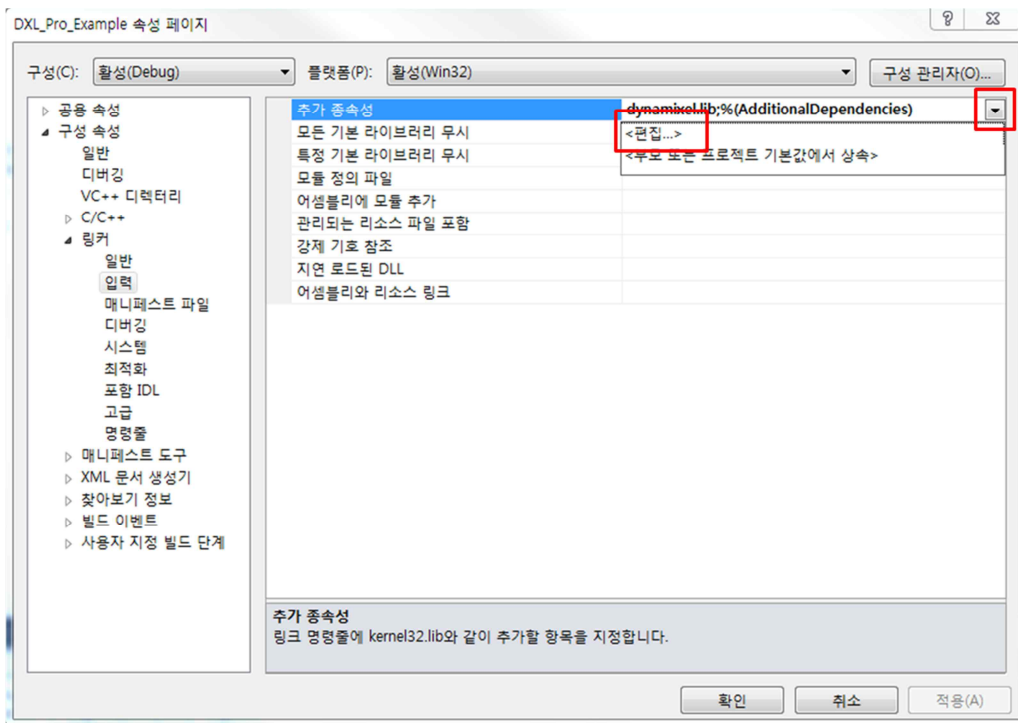

- Enter 'dynamixel.lib' and click on 'confirm' to save the changes.

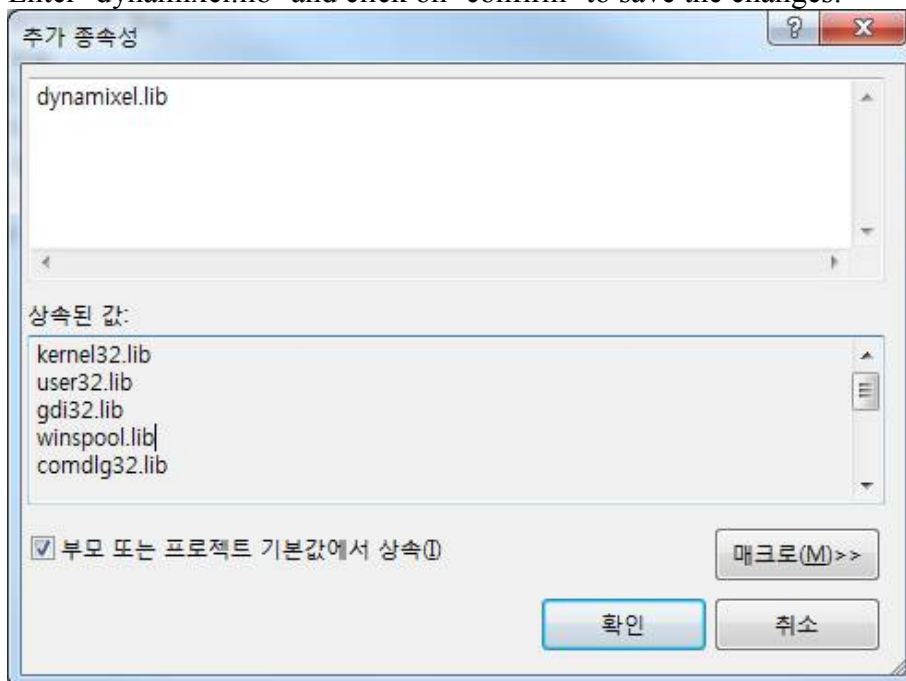

- Dynamixel SDK programming setup is complete.

ii. Initialize and terminate the connection with USB-to-Dynamixel dongle

- First, open a .cpp file and copy the code below. The **COM_PORT_NUM** and **BAUD_RATE_NUM** values need to match the proper USB-to-Dynamixel dongle in use.

```
#include "dynamixel.h"

#define COM_PORT_NUM 17 //Comport Number of USB2DXL
#define BAUD_RATE_NUM 1 //Baudrate Number of Dynamixel PRO
```

- The relationship between the baud rate number and the baud rate is indicated below.

Baudrate Number	Bps(= bit per seconds)
0	2400 bps
1	57600 bps
2	115200 bps
3	1 Mbps
4	2 Mbps
5	3 Mbps
6	4 Mbps
7	4.5 Mbps
8	10.5 Mbps

- Declare the ‘SerialPort’ type variable and then initialize all the values to zero.
- Declare the ‘SerialPort’ pointer type variable, then initialize it with address of the predefined variable. Please refer to the source code shown below.

```
SerialPort sp = {0,0,0,0,0};
SerialPort *Port = &sp;
```

- Next, implement functions, **dxl_initialize** and **dxl_terminate**, to connect and disconnect to USB-to-Dynamixel dongle.
- The program’s entire source is shown below.

```
main.cpp
#include <stdio.h>
#include <conio.h>
#include "dynamixel.h"

#define COM_PORT_NUM 17 //Comport Number of USB2DXL
#define BAUD_RATE_NUM 1 //Baudrate Number of Dynamixel PRO. 1 is 57600 bps
int main(void)
{
    SerialPort sp = {0,0,0,0,0};
    SerialPort *Port = &sp;

    //Open the port of USB2DXL
    if(dxl_initialize(Port, COM_PORT_NUM, BAUD_RATE_NUM) == COMM_RXSUCCESS )
```

```
        printf("Succeed to open USB2Dynamixel!\n");
else
{
    printf("Failed to open USB2Dynamixel!\n");
    printf("Press any key to terminate...\n");
    _getch();
    return 0;
}

printf("Press any key to terminate...\n");
getch();

//Close the port of USB2DXL
dxl_terminate(Port);

return 0;
}
```

- **COMM_RXSUCCESS** is returned when USB-to-Dynamixel dongle is successfully communicates with Dynamixel PRO.
- When using the Dynamixel SDK to communicate with USB-to-Dynamixel you can check if communication is successful.

1.2.2 Basic functions of Dynamixel PRO.

i. Turning the torque On/Off of Dynamixel PRO.

- As explained in 1.1, Dynamixel PRO's Control Table contains Torque Enable function that controls the torque to be on/off. The address for Torque Enable function is 562. Torque Enable is has 1 byte assigned.
- Therefore, implement **dxl_write_byte** function (See 2.4.3)
- The program's entire source is shown below.

main.cpp

```

#include <stdio.h>
#include <conio.h>
#include "dynamixel.h"

#define COM_PORT_NUM    17        //Comport Number of USB2DXL
#define BAUD_RATE_NUM   1         //Baudrate Number of Dynamixel PRO. 1 is 57600 bps

#define P_TORQUE_ENABLE 562       //Address of Torque Enable in Control Table
#define ID               1        //ID of Dynamixel PRO you use

int main(void)
{
    SerialPort sp = {0,0,0,0,0};
    SerialPort *Port = &sp;

    //Open the port of USB2DXL
    if(dx1_initialize(Port, COM_PORT_NUM, BAUD_RATE_NUM) == COMM_RXSUCCESS )
        printf("Succeed to open USB2Dynamixel!\n");
    else
    {
        printf( "Failed to open USB2Dynamixel!\n" );
        printf( "Press any key to terminate...\n" );
        _getch();
        return 0;
    }

    int ErrorStatus;
    int Result;

    //Torque ON
    printf( "Press any key to turn on the torque...\n" );
    _getch();
    Result = dxl_write_byte(Port, ID, P_TORQUE_ENABLE, 1, &ErrorStatus);

    //Torque OFF
    printf( "Press any key to turn off the torque...\n" );
    _getch();
    Result = dxl_write_byte(Port, ID, P_TORQUE_ENABLE, 0, &ErrorStatus);

    //Close the port of USB2DXL

```

```
printf( "Press any key to terminate...\n" );
_getch();
dxl_terminate(Port);

return 0;
}
```

- The functions, such as `dxl_initialize`, `dxl_write_byte`, etc..., are used to communicate with Dynamixel PRO. These functions return communication results.
- **COMM_RXSUCCESS** is returned for successful communications.

ii. Operating Dynamixel PRO using C programming language.

- As explained in 1.1, Dynamixel PRO's Control Table's Goal Position address is 562. Also, Goal Position is assigned 4 bytes of memory.
- Therefore, a function called `dxl_write_dword` function controls Goal position. (See 2.4.3)
- The program's entire source is shown below.

```
main.cpp
```

```
#include <stdio.h>
#include <conio.h>
#include "dynamixel.h"

#define COM_PORT_NUM    17           //Comport Number of USB2DXL
#define BAUD_RATE_NUM  1           //Baudrate Number of Dynamixel PRO. 1 is 57600 bps

#define P_TORQUE_ENABLE 562        //Address of Torque Enable in Control Table
#define P_GOAL_POSITION 596        //Address of Goal Position in Control Table
#define ID               1         //ID of Dynamixel PRO you use

int main(void)
{
    SerialPort sp = {0,0,0,0,0};
    SerialPort *Port = &sp;

    //Open the port of USB2DXL
    if(dxl_initialize(Port, COM_PORT_NUM, BAUD_RATE_NUM) == COMM_RXSUCCESS )
        printf("Succeed to open USB2Dynamixel!\n");
    else
    {
        printf( "Failed to open USB2Dynamixel!\n" );
        printf( "Press any key to terminate...\n" );
        _getch();
        return 0;
    }

    int Result, ErrorStatus;

    //Torque ON
    printf( "Torque On...\n" );
    Result = dxl_write_byte(Port, ID, P_TORQUE_ENABLE, 1, &ErrorStatus);
    if( Result != COMM_RXSUCCESS )
    {
        printf( "Failed to write!\n" );
        printf( "Press any key to terminate...\n" );
        _getch();
        return 0;
    }

    int Goal_Pos1 = 100000, Goal_Pos2 = -100000;
```

```
//Change the vlaue of goal position
printf("Press any key to roatate the Dynamixel PRO to position 1\n");
_getch();
Result = dxl_write_dword(Port, ID, P_GOAL_POSITION, Goal_Pos1, &ErrorStatus);
if( Result != COMM_RXSUCCESS )
{
    printf( " Failed to write!\n" );
    printf( "Press any key to terminate...\n" );
    _getch();
    return 0;
}

//Change the vlaue of goal position
printf("Press any key to roatate the Dynamixel PRO to position 2\n");
_getch();
Result = dxl_write_dword(Port, ID, P_GOAL_POSITION, Goal_Pos2, &ErrorStatus);
if( Result != COMM_RXSUCCESS )
{
    printf( " Failed to write!\n" );
    printf( "Press any key to terminate...\n" );
    _getch();
    return 0;
}

//Torque OFF
printf( "Press any key to turn off the torque...\n" );
_getch();
Result = dxl_write_dword(Port, ID, P_TORQUE_ENABLE, 0, &ErrorStatus);
if( Result != COMM_RXSUCCESS )
{
    printf( " Failed to write!\n" );
    printf( "Press any key to terminate...\n" );
    _getch();
    return 0;
}

//Close the port of USB2DXL
printf( "Press any key to terminate...\n" );
_getch();
dxl_terminate(Port);

return 0;
}
```

iii. Modifying Dynamixel PRO's ID using C programming language.

- As explained in 1.1, the address for the ID is 7 on the Control Table. ID can be modified with the function called `dxl_write_byte`.
- However, ID cannot be changed while the Torque Enable is on, so the torque must be turned off in order to change its value.
- The program's entire source is shown below.

```
main.cpp
```

```
#include <stdio.h>
#include <conio.h>
#include "dynamixel.h"

#define COM_PORT_NUM      17      //Comport Number of USB2DXL
#define BAUD_RATE_NUM    1       //Baudrate Number of Dynamixel PRO

#define P_ID              7       //Address of ID in Control Table
#define P_TORQUE_ENABLE  562     //Address of Torque Enable in Control Table

#define ID                1       //ID of Dynamixel PRO you use

// Print error bit of status packet
void PrintErrorCode(int ErrorCode)
{
    if(ErrorCode & ERRBIT_VOLTAGE)
        printf("Input voltage error!\n");

    if(ErrorCode & ERRBIT_ANGLE)
        printf("Angle limit error!\n");

    if(ErrorCode & ERRBIT_OVERHEAT)
        printf("Overheat error!\n");

    if(ErrorCode & ERRBIT_RANGE)
        printf("Out of range error!\n");

    if(ErrorCode & ERRBIT_CHECKSUM)
        printf("Checksum error!\n");

    if(ErrorCode & ERRBIT_OVERLOAD)
        printf("Overload error!\n");

    if(ErrorCode & ERRBIT_INSTRUCTION)
        printf("Instruction code error!\n");
}

int main(void)
{
    SerialPort sp = {0,0,0,0,0};
    SerialPort *Port = &sp;
```

```

//Open the port of USB2DXL
if(dx1_initialize(Port, COM_PORT_NUM, BAUD_RATE_NUM) == COMM_RXSUCCESS )
    printf("Succeed to open USB2Dynamixel!\n");
else
{
    printf( "Failed to open USB2Dynamixel!\n" );
    printf( "Press any key to terminate...\n" );
    _getch();
    return 0;
}

int Result, ErrorStatus;

//Torque Off
printf( "Torque Off...\n" );
Result = dx1_write_byte(Port, ID, P_TORQUE_ENABLE, 0, &ErrorStatus);
if( Result != COMM_RXSUCCESS )
{
    printf( "Failed to write!\n" );
    printf( "Press any key to terminate...\n" );
    _getch();
    return 0;
}

int desired_ID = 3;

//Change the ID of Dynamixel PRO you use
printf("Press any key to change the ID of Dynamixel PRO you use\n");
_getch();
Result = dx1_write_byte(Port, ID, P_ID, desired_ID, &ErrorStatus);
if( Result != COMM_RXSUCCESS )
{
    printf( "Failed to write!\n" );
    printf( "Press any key to terminate...\n" );
    _getch();
    return 0;
}
else
{
    if(ErrorStatus != 0 )
        PrintErrorCode(ErrorStatus);
    else
        printf("Succeed to chagne the ID of Dynamixel PRO you use!\n");
}

//Close the port of USB2DXL
printf( "Press any key to terminate...\n" );
_getch();
dx1_terminate(Port);

```



```

return 0;
}
    
```

- The return pointer of the read/write functions returns the error/status code sent from Dynamixel PRO.
- Please refer to 2.4.2 for detailed information regarding error values.
- Check the ID that is modified using Dynamixel Wizard.

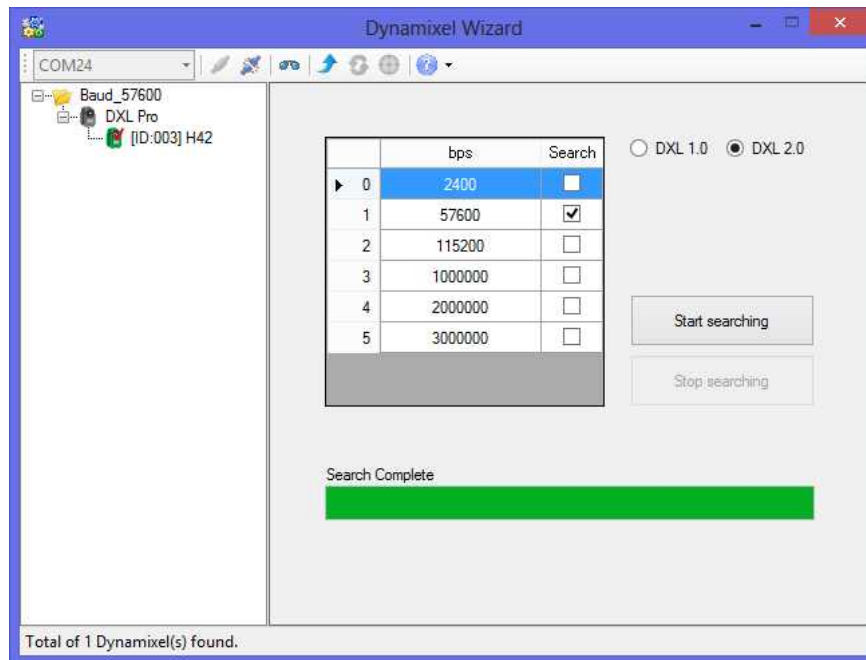

iv. Modifying the baud rate of Dynamixel PRO.

- Please use Dynamixel Wizard to change Dynamixel PRO ID to 1.
- As explained in 1.1, the baud rate of Dynamixel PRO on the Control Table is in address #8. Also, the baud rate is assigned with 1 byte so it can be modified by implementing **dxl_write_byte** function.
- The baud rate cannot be changed while Dynamixel PRO is in torque on status. Torque must be turned off in order to change its value.
- The program’s entire source is shown below.

```

main.cpp
#include <stdio.h>
#include <conio.h>
#include "dynamixel.h"

#define COM_PORT_NUM      17      //Comport Number of USB2DXL
#define BAUD_RATE_NUM     1       //Baudrate Number of Dynamixel PRO

#define P_BAUD_RATE       8       //Address of ID in Contorl Table
#define P_TORQUE_ENABLE   562     //Address of Torque Enable in Control Table

#define ID                 1      //ID of Dynamixel PRO you use
    
```

```

// Print error bit of status packet
void PrintErrorCode(int ErrorCode)
{
    if(ErrorCode & ERRBIT_VOLTAGE)
        printf("Input voltage error!\n");

    if(ErrorCode & ERRBIT_ANGLE)
        printf("Angle limit error!\n");

    if(ErrorCode & ERRBIT_OVERHEAT)
        printf("Overheat error!\n");

    if(ErrorCode & ERRBIT_RANGE)
        printf("Out of range error!\n");

    if(ErrorCode & ERRBIT_CHECKSUM)
        printf("Checksum error!\n");

    if(ErrorCode & ERRBIT_OVERLOAD)
        printf("Overload error!\n");

    if(ErrorCode & ERRBIT_INSTRUCTION)
        printf("Instruction code error!\n");
}

int main(void)
{
    SerialPort sp = {0,0,0,0,0};
    SerialPort *Port = &sp;

    //Open the port of USB2DXL
    if(dx1_initialize(Port, COM_PORT_NUM, BAUD_RATE_NUM) == COMM_RXSUCCESS )
        printf("Succeed to open USB2Dynamixel!\n");
    else
    {
        printf( "Failed to open USB2Dynamixel!\n" );
        printf( "Press any key to terminate...\n" );
        _getch();
        return 0;
    }

    int Result, ErrorStatus;

    //Torque Off
    printf( "Torque Off...\n" );
    Result = dx1_write_byte(Port, ID, P_TORQUE_ENABLE, 0, &ErrorStatus);
    if( Result != COMM_RXSUCCESS )
    {
        printf( "Failed to write!\n" );
    }
}

```

```
        printf( "Press any key to terminate...\n" );
        _getch();
        return 0;
    }

    int desired_Baudrate = 3; //1 Mbps

    //Change the ID of Dynamixel PRO you use
    printf("Press any key to change the baudrate of Dynamixel PRO you use\n");
    _getch();
    Result = dxl_write_byte(Port, ID, P_BAUD_RATE, 3, &ErrorStatus);
    if( Result != COMM_RXSUCCESS )
    {
        printf( "Failed to write!\n" );
        printf( "Press any key to terminate...\n" );
        _getch();
        return 0;
    }
    else
    {
        if(ErrorStatus != 0 )
            PrintErrorCode(ErrorStatus);
        else
            printf("Succeed to chage the baudrate of Dynamixel PRO you use!\n");
    }

    //Close the port of USB2DXL
    printf( "Press any key to terminate...\n" );
    _getch();
    dxl_terminate(Port);

    return 0;
}
```

- Use Dynamixel Wizard to check if the baud rate has been changed to 1 Mbps.

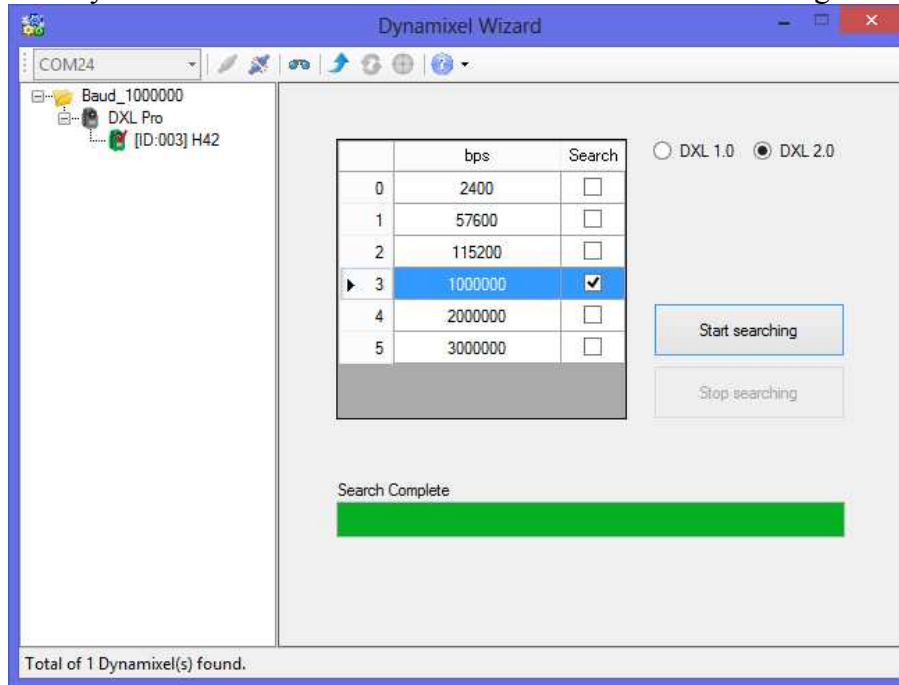

- If the baud rate has not been changed check if Dynamixel PRO is in torque off status.
- The following content assumes Dynamixel PRO's baud rate set to 1 Mbps.

v. LED control of Dynamixel PRO

- The baud rate is now 1 Mbps therefore the code must be implemented as follows:

```
#define COM_PORT_NUM      17      //Comport Number of USB2DXL
#define BAUD_RATE_NUM     3       //Baudrate Number of Dynamixel PRO
```

- As explained in 1.1, Dynamixel PRO Control Table contains 3 addresses for the LEDs, each assigned with 1 byte of memory: LED_RED (#563), LED_GREEN (#564), and LED_BLUE (#565). Implement `dxl_write_byte` function to control its values.
- Since LED is assigned with 1 byte of memory select values between 0~255 to control the brightness of the LED.
- The program's entire source is shown below.

```
main.cpp
```

```
#include <stdio.h>
#include <conio.h>
#include "dynamixel.h"

#define COM_PORT_NUM      17      //Comport Number of USB2DXL
#define BAUD_RATE_NUM     3       //Baudrate Number of Dynamixel PRO

#define P_LED_RED         563     //Address of LED_RED in Control Table
#define P_LED_GREEN       564     //Address of LED_GREEN in Control Table
#define P_LED_BLUE        565     //Address of LED_BLUE in Control Table

#define ID                 1      //ID of Dynamixel PRO you use

// Print error bit of status packet
void PrintErrorCode(int ErrorCode)
{
    if(ErrorCode & ERRBIT_VOLTAGE)
        printf("Input voltage error!\n");

    if(ErrorCode & ERRBIT_ANGLE)
        printf("Angle limit error!\n");

    if(ErrorCode & ERRBIT_OVERHEAT)
        printf("Overheat error!\n");

    if(ErrorCode & ERRBIT_RANGE)
        printf("Out of range error!\n");

    if(ErrorCode & ERRBIT_CHECKSUM)
        printf("Checksum error!\n");

    if(ErrorCode & ERRBIT_OVERLOAD)
        printf("Overload error!\n");

    if(ErrorCode & ERRBIT_INSTRUCTION)
```

```

    printf("Instruction code error!\n");
}

int main(void)
{
    SerialPort sp = {0,0,0,0,0};
    SerialPort *Port = &sp;

    //Open the port of USB2DXL
    if(dx1_initialize(Port, COM_PORT_NUM, BAUD_RATE_NUM) == COMM_RXSUCCESS )
        printf("Succeed to open USB2Dynamixel!\n");
    else
    {
        printf("Failed to open USB2Dynamixel!\n");
        printf("Press any key to terminate...\n");
        _getch();
        return 0;
    }

    int Result, ErrorStatus;

    //Turn off the LED
    Result = dx1_write_byte(Port, ID, P_LED_RED, 0, &ErrorStatus);
    Result = dx1_write_byte(Port, ID, P_LED_GREEN, 0, &ErrorStatus);
    Result = dx1_write_byte(Port, ID, P_LED_BLUE, 0, &ErrorStatus);

    //Turn on and change the color of LED in Dynamixel PRO
    printf("Press any key to change the color of LED in Dynamixel PRO\n");
    _getch();
    Result = dx1_write_byte(Port, ID, P_LED_RED, 255, &ErrorStatus);
    if( Result != COMM_RXSUCCESS )
    {
        printf("Failed to write!\n");
        printf("Press any key to terminate...\n");
        _getch();
        return 0;
    }
    else
    {
        if(ErrorStatus != 0 )
            PrintErrorCode(ErrorStatus);
        else
            printf("Succeed to change the color of LED in Dynamixel PRO!\n");
    }

    printf("Press any key to change the color of LED in Dynamixel PRO\n");
    _getch();
    Result = dx1_write_byte(Port, ID, P_LED_RED, 0, &ErrorStatus);
    Result = dx1_write_byte(Port, ID, P_LED_GREEN, 255, &ErrorStatus);
    if( Result != COMM_RXSUCCESS )

```

```

    {
        printf( "Failed to write!\n" );
        printf( "Press any key to terminate...\n" );
        _getch();
        return 0;
    }
else
{
    if(ErrorStatus != 0 )
        PrintErrorCode(ErrorStatus);
    else
        printf("Succeed to change the color of LED in Dynamixel PRO!\n");
}

printf("Press any key to change the color of LED in Dynamixel PRO\n");
_getch();
Result = dxl_write_byte(Port, ID, P_LED_GREEN, 0, &ErrorStatus);
Result = dxl_write_byte(Port, ID, P_LED_BLUE, 255, &ErrorStatus);
if( Result != COMM_RXSUCCESS )
{
    printf( "Failed to write!\n" );
    printf( "Press any key to terminate...\n" );
    _getch();
    return 0;
}
else
{
    if(ErrorStatus != 0 )
        PrintErrorCode(ErrorStatus);
    else
        printf("Succeed to change the color of LED in Dynamixel PRO!\n");
}

//Close the port of USB2DXL
printf( "Press any key to terminate...\n" );
_getch();
dxl_terminate(Port);
return 0;
}

```

- Try controlling the intensity of the LED light.

vi. Modifying the P gain value of Dynamixel PRO

- Let's control the P gain value of Dynamixel PRO's position.
- Dynamixel PRO implements PID control to manipulate its motor; therefore, the movement changes corresponding to the gain values.
- On Dynamixel PRO's Control Table, the Position_P_Gain address is set as 594 and it utilizes 2 bytes (1 word) of memory.
- Thus, **dxl_write_word** function, which modifies 2 bytes of memory, changes the P gain value.
- The program's entire source is shown below.

```

main.cpp
#include <stdio.h>
#include <conio.h>
#include "dynamixel.h"

#define COM_PORT_NUM          17      //Comport Number of USB2DXL
#define BAUD_RATE_NUM         3       //Baudrate Number of Dynamixel PRO
#define P_TORQUE_ENABLE       562     //Address of Torque Enable in Control Table
#define P_POSITION_P_GAIN     594     //Address of Position P Gain in Control Table
#define P_GOAL_POSITION       596     //Address of Goal Position in Control Table

#define ID                     1      //ID of Dynamixel PRO you use

// Print error bit of status packet
void PrintErrorCode(int ErrorCode)
{
    if(ErrorCode & ERRBIT_VOLTAGE)
        printf("Input voltage error!\n");

    if(ErrorCode & ERRBIT_ANGLE)
        printf("Angle limit error!\n");

    if(ErrorCode & ERRBIT_OVERHEAT)
        printf("Overheat error!\n");

    if(ErrorCode & ERRBIT_RANGE)
        printf("Out of range error!\n");

    if(ErrorCode & ERRBIT_CHECKSUM)
        printf("Checksum error!\n");

    if(ErrorCode & ERRBIT_OVERLOAD)
        printf("Overload error!\n");

    if(ErrorCode & ERRBIT_INSTRUCTION)
        printf("Instruction code error!\n");
}

int main(void)

```



```

{
    SerialPort sp = {0,0,0,0,0};
    SerialPort *Port = &sp;

    //Open the port of USB2DXL
    if(dx1_initialize(Port, COM_PORT_NUM, BAUD_RATE_NUM) == COMM_RXSUCCESS )
        printf("Succeed to open USB2Dynamixel!\n");
    else
    {
        printf( "Failed to open USB2Dynamixel!\n" );
        printf( "Press any key to terminate...\n" );
        _getch();
        return 0;
    }

    int Result, ErrorStatus;

    //Torque on
    printf( "Torque on...\n" );
    Result = dx1_write_byte(Port, ID, P_TORQUE_ENABLE, 1, &ErrorStatus);
    if( Result != COMM_RXSUCCESS )
    {
        printf( "Failed to write!\n" );
        printf( "Press any key to terminate...\n" );
        _getch();
        return 0;
    }

    //change the position p gain
    printf("Press any key to change the position p gain\n");
    _getch();
    Result = dx1_write_word(Port, ID, P_POSITION_P_GAIN, 8, &ErrorStatus);
    if( Result != COMM_RXSUCCESS )
    {
        printf( "Failed to write!\n" );
        printf( "Press any key to terminate...\n" );
        _getch();
        return 0;
    }
    else
    {
        if(ErrorStatus != 0 )
            PrintErrorCode(ErrorStatus);
    }

    //change the goal position value
    printf("Press any key to change the goal position\n");
    _getch();
    Result = dx1_write_dword(Port, ID, P_GOAL_POSITION, 100000, &ErrorStatus);
    if( Result != COMM_RXSUCCESS )

```

```

    {
        printf( "Failed to write!\n" );
        printf( "Press any key to terminate...\n" );
        _getch();
        return 0;
    }
else
{
    if(ErrorStatus != 0 )
        PrintErrorCode(ErrorStatus);
}

//change the position p gain
printf("Press any key to change the position p gain\n");
_getch();
Result = dxl_write_word(Port, ID, P_POSITION_P_GAIN, 256, &ErrorStatus);
if( Result != COMM_RXSUCCESS )
{
    printf( "Failed to write!\n" );
    printf( "Press any key to terminate...\n" );
    _getch();
    return 0;
}
else
{
    if(ErrorStatus != 0 )
        PrintErrorCode(ErrorStatus);
}

//change the goal position value
printf("Press any key to change the goal position\n");
_getch();
Result = dxl_write_dword(Port, ID, P_GOAL_POSITION, -100000, &ErrorStatus);
if( Result != COMM_RXSUCCESS )
{
    printf( "Failed to write!\n" );
    printf( "Press any key to terminate...\n" );
    _getch();
    return 0;
}
else
{
    if(ErrorStatus != 0 )
        PrintErrorCode(ErrorStatus);
}

//Close the port of USB2DXL
printf( "Press any key to terminate...\n" );
_getch();
dxl_terminate(Port);

```

```
}  
    return 0;  
}
```

- Observe the difference in Dynamixel PRO's movement speed relevant to the change in P Gain values.

vii. Operating Dynamixel PRO in various speeds

- To control the movement speed in Joint Mode change the Goal Velocity.
- There are two methods in changing the Goal Position and Goal Velocity of Dynamixel PRO.
- First, implement `dxl_write_dword` function twice to change the values. Second, implement `dxl_write` function to simultaneously change the Goal Position and Goal Velocity (see 2.44).
- Since we have gone over `dxl_write_byte`, `dxl_write_word`, and `dxl_write_dword`, please try the second method to change the Goal Position and Goal Velocity of Dynamixel PRO.
- Goal Position and Goal Velocity both use 2 bytes each (or 1 word each).
- Thus, in order to simultaneously change the Goal Position and Goal Velocity, 8 bytes of data needs to be transferred. You need to modify the data accordingly.
- The data can be written like the example below.

```
int position, velocity;
position = 100000;
velocity = 10000;

//Make a tx data
unsigned char data[8];
data[0] = DXL_LOBYTE(DXL_LOWORD(position));
data[1] = DXL_HIBYTE(DXL_LOWORD(position));
data[2] = DXL_LOBYTE(DXL_HIWORD(position));
data[3] = DXL_HIBYTE(DXL_HIWORD(position));
data[4] = DXL_LOBYTE(DXL_LOWORD(velocity));
data[5] = DXL_HIBYTE(DXL_LOWORD(velocity));
data[6] = DXL_LOBYTE(DXL_HIWORD(velocity));
data[7] = DXL_HIBYTE(DXL_HIWORD(velocity));
```

- The goal position and goal velocity values are entered into the `unsigned char` type array implementing `DXL_LOWORD`, `DXL_HIWORD`, `DXL_LOBYTE`, and `DXL_HIBYTE` functions.
- Next, use `dxl_write` function to send the configured data to Dynamixel PRO.

```
dxl_write(Port, ID, P_GOAL_POSITION, 8, data, &ErrorStatus);
```

- To simultaneously change the Goal Position and Goal Velocity implement `dxl_write` function to modify 8 bytes of memory.
- The program's entire source is shown below.

```
main.cpp
#include <stdio.h>
#include <conio.h>
#include "dynamixel.h"

#define COM_PORT_NUM          17      //Comport Number of USB2DXL
#define BAUD_RATE_NUM        3       //Baudrate Number of Dynamixel PRO
```

```

#define P_TORQUE_ENABLE      562      //Address of Torque Enable in Control Table
#define P_GOAL_POSITION      596      //Address of Goal Position in Control Table

#define ID                    1        //ID of Dynamixel PRO you use

// Print error bit of status packet
void PrintErrorCode(int ErrorCode)
{
    if(ErrorCode & ERRCODE_VOLTAGE)
        printf("Input voltage error!\n");

    if(ErrorCode & ERRCODE_ANGLE)
        printf("Angle limit error!\n");

    if(ErrorCode & ERRCODE_OVERHEAT)
        printf("Overheat error!\n");

    if(ErrorCode & ERRCODE_RANGE)
        printf("Out of range error!\n");

    if(ErrorCode & ERRCODE_CHECKSUM)
        printf("Checksum error!\n");

    if(ErrorCode & ERRCODE_OVERLOAD)
        printf("Overload error!\n");

    if(ErrorCode & ERRCODE_INSTRUCTION)
        printf("Instruction code error!\n");
}

int main(void)
{
    SerialPort sp = {0,0,0,0,0};
    SerialPort *Port = &sp;

    //Open the port of USB2DXL
    if(dx1_initialize(Port, COM_PORT_NUM, BAUD_RATE_NUM) == COMM_RXSUCCESS )
        printf("Succeed to open USB2Dynamixel!\n");
    else
    {
        printf("Failed to open USB2Dynamixel!\n");
        printf("Press any key to terminate...\n");
        _getch();
        return 0;
    }

    int Result, ErrorStatus;

    //Torque on
    printf("Torque on...\n");
}

```

```

Result = dxl_write_byte(Port, ID, P_TORQUE_ENABLE, 1, &ErrorStatus);
if( Result != COMM_RXSUCCESS )
{
    printf( "Failed to write!\n" );
    printf( "Press any key to terminate...\n" );
    _getch();
    return 0;
}

int position, velocity;
position = 100000;
velocity = 10000;

//Make a tx data
unsigned char data[8];
data[0] = DXL_LOBYTE(DXL_LOWORD(position));
data[1] = DXL_HIBYTE(DXL_LOWORD(position));
data[2] = DXL_LOBYTE(DXL_HIWORD(position));
data[3] = DXL_HIBYTE(DXL_HIWORD(position));
data[4] = DXL_LOBYTE(DXL_LOWORD(velocity));
data[5] = DXL_HIBYTE(DXL_LOWORD(velocity));
data[6] = DXL_LOBYTE(DXL_HIWORD(velocity));
data[7] = DXL_HIBYTE(DXL_HIWORD(velocity));

//change the position value and moving speed
printf( "Press any key to change the position value and moving speed...\n" );
_getch();
Result = dxl_write(Port, ID, P_GOAL_POSITION, 8, data, &ErrorStatus);
if( Result != COMM_RXSUCCESS )
{
    printf( "Failed to write!\n" );
    printf( "Press any key to terminate...\n" );
    _getch();
    return 0;
}
else
{
    if(ErrorStatus != 0 )
        PrintErrorCode(ErrorStatus);
}

position = -100000;
velocity = 2000;
//Make a tx data
data[0] = DXL_LOBYTE(DXL_LOWORD(position));
data[1] = DXL_HIBYTE(DXL_LOWORD(position));
data[2] = DXL_LOBYTE(DXL_HIWORD(position));
data[3] = DXL_HIBYTE(DXL_HIWORD(position));
data[4] = DXL_LOBYTE(DXL_LOWORD(velocity));

```

```

data[5] = DXL_HIBYTE(DXL_LOWORD(velocity));
data[6] = DXL_LOBYTE(DXL_HIWORD(velocity));
data[7] = DXL_HIBYTE(DXL_HIWORD(velocity));

//change the position value and moving speed
printf( "Press any key to change the position value and moving speed...\n" );
_getch();
Result = dxl_write(Port, ID, P_GOAL_POSITION, 8, data, &ErrorStatus);
if( Result != COMM_RXSUCCESS )
{
    printf( "Failed to write!\n" );
    printf( "Press any key to terminate...\n" );
    _getch();
    return 0;
}
else
{
    if(ErrorStatus != 0 )
        PrintErrorCode(ErrorStatus);
}

//Close the port of USB2DXL
printf( "Press any key to terminate...\n" );
_getch();
dxl_terminate(Port);
return 0;
}

```

- The velocity should be fast when rotating towards the first position and slower when rotating towards the second position.

viii. Internal temperature feedback of Dynamixel PRO

- So far, we have covered how to use the Write command to send commands to Dynamixel PRO.
- Next, we will go over how to use the Read command to receive data from Dynamixel PRO.
- The address of Present Temperature on the Control Table is 625 and is assigned 1 byte of memory.
- Thus, dxl_read_byte function can be used to obtain the Current Temperature of Dynamixel PRO.
- The program's entire source is shown below.

main.cpp

```

#include <stdio.h>
#include <conio.h>
#include "dynamixel.h"

#define COM_PORT_NUM          17      //Comport Number of USB2DXL
#define BAUD_RATE_NUM        3       //Baudrate Number of Dynamixel PRO
#define P_PRESENT_TEMPERATURE 625    //Address of Present Temperature in Control
Table

#define ID                    1       //ID of Dynamixel PRO you use

// Print error bit of status packet
void PrintErrorCode(int ErrorCode)
{
    if(ErrorCode & ERRCODE_VOLTAGE)
        printf("Input voltage error!\n");

    if(ErrorCode & ERRCODE_ANGLE)
        printf("Angle limit error!\n");

    if(ErrorCode & ERRCODE_OVERHEAT)
        printf("Overheat error!\n");

    if(ErrorCode & ERRCODE_RANGE)
        printf("Out of range error!\n");

    if(ErrorCode & ERRCODE_CHECKSUM)
        printf("Checksum error!\n");

    if(ErrorCode & ERRCODE_OVERLOAD)
        printf("Overload error!\n");

    if(ErrorCode & ERRCODE_INSTRUCTION)
        printf("Instruction code error!\n");
}

int main(void)

```



```

{
    SerialPort sp = {0,0,0,0,0};
    SerialPort *Port = &sp;

    //Open the port of USB2DXL
    if(dx1_initialize(Port, COM_PORT_NUM, BAUD_RATE_NUM) == COMM_RXSUCCESS )
        printf("Succeed to open USB2Dynamixel!\n");
    else
    {
        printf( "Failed to open USB2Dynamixel!\n" );
        printf( "Press any key to terminate...\n" );
        _getch();
        return 0;
    }

    int Result, ErrorStatus;

    printf("Press any key to terminate...\n" );
    printf("\n");
    int temp;
    while(true)
    {
        if(_kbhit())
            break;

        //Read the present temperature
        Result = dx1_read_byte(Port, ID,
                               P_PRESENT_TEMPERATURE, &temp, &ErrorStatus);
        if( Result != COMM_RXSUCCESS )
        {
            printf( "Failed to write!\n" );
            printf( "Press any key to terminate...\n" );
            _getch();
            return 0;
        }
        else
        {
            PrintErrorCode(ErrorStatus);
        }

        printf("\r");
        printf("current temperature : %d", temp);
    }

    //Close the port of USB2DXL
    dx1_terminate(Port);
    return 0;
}

```

- The present temperature is constantly read.

ix. Read the Present Position of Dynamixel PRO

- Present Position indicates the present position of Dynamixel PRO Its address is 611 and is assigned 4 bytes of memory.
- Therefore, implement `dxl_read_dword` function present position of Dynamixel PRO.
- The program's entire source is shown below.

```
main.cpp
```

```
#include <stdio.h>
#include <conio.h>
#include "dynamixel.h"

#define COM_PORT_NUM          17      //Comport Number of USB2DXL
#define BAUD_RATE_NUM         3       //Baudrate Number of Dynamixel PRO
#define P_PRESENT_POSITION    611     //Address of Present Position in Contorl Table

#define ID                    1       //ID of Dynamixel PRO you use

// Print error bit of status packet
void PrintErrorCode(int ErrorCode)
{
    if(ErrorCode & ERRBIT_VOLTAGE)
        printf("Input voltage error!\n");

    if(ErrorCode & ERRBIT_ANGLE)
        printf("Angle limit error!\n");

    if(ErrorCode & ERRBIT_OVERHEAT)
        printf("Overheat error!\n");

    if(ErrorCode & ERRBIT_RANGE)
        printf("Out of range error!\n");

    if(ErrorCode & ERRBIT_CHECKSUM)
        printf("Checksum error!\n");

    if(ErrorCode & ERRBIT_OVERLOAD)
        printf("Overload error!\n");

    if(ErrorCode & ERRBIT_INSTRUCTION)
        printf("Instruction code error!\n");
}

int main(void)
{
    SerialPort sp = {0,0,0,0,0};
    SerialPort *Port = &sp;

    //Open the port of USB2DXL
    if(dxl_initialize(Port, COM_PORT_NUM, BAUD_RATE_NUM) == COMM_RXSUCCESS )
```

```

        printf("Succeed to open USB2Dynamixel!\n");
    else
    {
        printf( "Failed to open USB2Dynamixel!\n" );
        printf( "Press any key to terminate...\n" );
        _getch();
        return 0;
    }

    int Result, ErrorStatus;

    printf("Press any key to terminate...\n" );
    printf("\n");
    int temp;
    while(true)
    {
        if(_kbhit())
            break;

        //Read the present position
        Result = dxl_read_dword(Port, ID, P_PRESENT_POSITION, (unsigned*)&temp,
&ErrorStatus);
        if( Result != COMM_RXSUCCESS )
        {
            printf( "Failed to write!\n" );
            printf( "Press any key to terminate...\n" );
            _getch();
            return 0;
        }
        else
        {
            PrintErrorCode(ErrorStatus);
        }

        printf("\r");
        printf("present position : %d", temp);
    }

    //Close the port of USB2DXL
    dxl_terminate(Port);
    return 0;
}

```

- The Present Position is shown when the program is initiated.

x. Changing velocity of Dynamixel PRO in Wheel Mode

- On Dynamixel PRO's Control Table the address for Operating Mode is 11. It requires 1 byte of memory. By changing the value of the Operating Mode Dynamixel PRO can be set to Joint Mode, Wheel Mode, or Torque Mode,
- Implement **dxl_write_byte** to change Operating Mode. It is a part of the EEPROM area so the Torque Enable must be off to modify its value.
- Also, as shown in 1.1, Torque Enable needs to be on to activate Dynamixel PRO in Wheel Mode. The speed of Dynamixel PRO can be controlled by modifying the Goal_Velocity values.
- The program's entire source code is shown below.

```
main.cpp
```

```
#include <Windows.h>
#include <stdio.h>
#include <conio.h>
#include "dynamixel.h"

#define COM_PORT_NUM          17      //Comport Number of USB2DXL
#define BAUD_RATE_NUM        3       //Baudrate Number of Dynamixel PRO

#define P_OPERATING_MODE     11      //Address of Operation Mode in Control Table
#define P_TORQUE_ENABLE      562    //Address of Torque Enable in Control Table
#define P_GOAL_VELOCITY      600    //Address of Goal Velocity in Control Table

#define ID                    1      //ID of Dynamixel PRO you use

// Print error bit of status packet
void PrintErrorCode(int ErrorCode)
{
    if(ErrorCode & ERBBIT_VOLTAGE)
        printf("Input voltage error!\n");

    if(ErrorCode & ERBBIT_ANGLE)
        printf("Angle limit error!\n");

    if(ErrorCode & ERBBIT_OVERHEAT)
        printf("Overheat error!\n");

    if(ErrorCode & ERBBIT_RANGE)
        printf("Out of range error!\n");

    if(ErrorCode & ERBBIT_CHECKSUM)
        printf("Checksum error!\n");

    if(ErrorCode & ERBBIT_OVERLOAD)
        printf("Overload error!\n");

    if(ErrorCode & ERBBIT_INSTRUCTION)
        printf("Instruction code error!\n");
}
```

```

}

int main(void)
{
    SerialPort sp = {0,0,0,0,0};
    SerialPort *Port = &sp;

    //Open the port of USB2DXL
    if(dx1_initialize(Port, COM_PORT_NUM, BAUD_RATE_NUM) == COMM_RXSUCCESS )
        printf("Succeed to open USB2Dynamixel!\n");
    else
    {
        printf( "Failed to open USB2Dynamixel!\n" );
        printf( "Press any key to terminate...\n" );
        _getch();
        return 0;
    }

    int Result, ErrorStatus;

    //Torque Off
    printf( "Torque Off...\n" );
    Result = dx1_write_byte(Port, ID, P_TORQUE_ENABLE, 0, &ErrorStatus);
    if( Result != COMM_RXSUCCESS )
    {
        printf( "Failed to write!\n" );
        printf( "Press any key to terminate...\n" );
        _getch();
        return 0;
    }

    printf("Press any key to change the operating mode...\n");
    _getch();
    Result = dx1_write_byte(Port, ID, P_OPERATING_MODE, 1, &ErrorStatus);
    if( Result != COMM_RXSUCCESS )
    {
        printf( "Failed to write!\n" );
        printf( "Press any key to terminate...\n" );
        _getch();
        return 0;
    }
    else
    {
        if(ErrorStatus != 0 )
            PrintErrorCode(ErrorStatus);
        else
            printf("Succeed to chage the operationg mode!\n");
    }

    //Torque On

```

```

printf( "Torque On...\n" );
Result = dxl_write_byte(Port, ID, P_TORQUE_ENABLE, 1, &ErrorStatus);
if( Result != COMM_RXSUCCESS )
{
    printf( "Failed to write!\n" );
    printf( "Press any key to terminate...\n" );
    _getch();
    return 0;
}

//Change the Goal Velocity
printf("Press any key to change goal velocity...\n");
_getch();
Result = dxl_write_dword(Port, ID, P_GOAL_VELOCITY, 5000, &ErrorStatus);
if( Result != COMM_RXSUCCESS )
{
    printf( "Failed to write!\n" );
    printf( "Press any key to terminate...\n" );
    _getch();
    return 0;
}
else
{
    if(ErrorStatus != 0 )
        PrintErrorCode(ErrorStatus);
    else
        printf("Succeed to chage the operationg mode!\n");
}

//Close the port of USB2DXL
printf( "Press any key to terminate...\n" );
_getch();

//Torque Off
printf( "Torque Off...\n" );
Result = dxl_write_byte(Port, ID, P_TORQUE_ENABLE, 0, &ErrorStatus);
if( Result != COMM_RXSUCCESS )
{
    printf( "Failed to write!\n" );
    printf( "Press any key to terminate...\n" );
    _getch();
    return 0;
}

dxl_terminate(Port);
return 0;
}

```

xi. Checking the current position and current velocity of Dynamixel PRO

- There are two methods to check the present position of Dynamixel PRO.
- First, is to implement `dxl_read_dword` function twice to change the values. Second, is to implement `dxl_read` function to simultaneously read the Present Position and Present Velocity.
- You have gone over `dxl_read_byte`, `dxl_read_word`, and `dxl_tead_dword`, This time implement the second method to change the Goal Position and Goal Velocity of Dynamixel PRO.
- Both Goal Position and Goal Velocity require 4 bytes.
- Thus, to simultaneously read the Present Position and Present Velocity you need to modify the data length accordingly.
- Data can be read by entering the data type as shown on the example below.

```

unsigned char data[8];
dxl_read(Port, ID, P_PRESENT_POSITION, 8, data, &ErrorStatus);

int present_position, present_velocity;
present_position=DXL_MAKEDWORD(DXL_MAKEWORD(data[0],data[1]),DXL_MAKEWORD(data[2],data[3]));
present_velocity=DXL_MAKEDWORD(DXL_MAKEWORD(data[4],data[5]),DXL_MAKEWORD(data[6],data[7]));

```

- The `unsigned char` type array data obtained is converted into the present position and velocity with `DXL_MAKEWORD`, `DXL_MAKEDWORD` (refer to the source code above).
- The program's entire source code is shown below.

```

main.cpp
#include <stdio.h>
#include <conio.h>
#include "dynamixel.h"

#define COM_PORT_NUM          17          //Comport Number of USB2DXL
#define BAUD_RATE_NUM        3           //Baudrate Number of Dynamixel PRO

#define P_OPERATING_MODE     11          //Address of Operation Mode in Control Table
#define P_TORQUE_ENABLE      562        //Address of Torque Enable in Control Table
#define P_GOAL_POSITION      596        //Address of Goal Position in Control Table
#define P_GOAL_VELOCITY     600        //Address of Goal Velocity in Control Table
#define P_PRESENT_POSITION   611        //Address of Present Position in Control Table
#define P_PRESENT_VELOCITY   615        //Address of Present Velocity in Control Table

#define ID                    1          //ID of Dynamixel PRO you use

// Print error bit of status packet
void PrintErrorCode(int ErrorCode)
{
    if(ErrorCode & ERROBIT_VOLTAGE)
        printf("Input voltage error!\n");
}

```



```

if(ErrorCode & ERBBIT_ANGLE)
    printf("Angle limit error!\n");

if(ErrorCode & ERBBIT_OVERHEAT)
    printf("Overheat error!\n");

if(ErrorCode & ERBBIT_RANGE)
    printf("Out of range error!\n");

if(ErrorCode & ERBBIT_CHECKSUM)
    printf("Checksum error!\n");

if(ErrorCode & ERBBIT_OVERLOAD)
    printf("Overload error!\n");

if(ErrorCode & ERBBIT_INSTRUCTION)
    printf("Instruction code error!\n");
}

int main(void)
{
    SerialPort sp = {0,0,0,0,0};
    SerialPort *Port = &sp;

    //Open the port of USB2DXL
    if(dx1_initialize(Port, COM_PORT_NUM, BAUD_RATE_NUM) == COMM_RXSUCCESS )
        printf("Succeed to open USB2Dynamixel!\n");
    else
    {
        printf( "Failed to open USB2Dynamixel!\n" );
        printf( "Press any key to terminate...\n" );
        _getch();
        return 0;
    }

    int Result, ErrorStatus;

    //Torque Off
    printf( "Torque Off...\n" );
    Result = dx1_write_byte(Port, ID, P_TORQUE_ENABLE, 0, &ErrorStatus);
    if( Result != COMM_RXSUCCESS )
    {
        printf( "Failed to write!\n" );
        printf( "Press any key to terminate...\n" );
        _getch();
        return 0;
    }

    printf("Press any key to change the operating mode...\n");

```

```

_getch();
Result = dxl_write_byte(Port, ID, P_OPERATING_MODE, 1, &ErrorStatus);
if( Result != COMM_RXSUCCESS )
{
    printf( "Failed to write!\n" );
    printf( "Press any key to terminate...\n" );
    _getch();
    return 0;
}
else
{
    if(ErrorStatus != 0 )
        PrintErrorCode(ErrorStatus);
    else
        printf("Succeed to chage the operationg mode!\n");
}

//Torque On
printf( "Torque On...\n" );
Result = dxl_write_byte(Port, ID, P_TORQUE_ENABLE, 1, &ErrorStatus);
if( Result != COMM_RXSUCCESS )
{
    printf( "Failed to write!\n" );
    printf( "Press any key to terminate...\n" );
    _getch();
    return 0;
}

//Change the Goal Velocity
printf("Press any key to change goal velocity...\n");
_getch();
Result = dxl_write_dword(Port, ID, P_GOAL_VELOCITY, 5000, &ErrorStatus);
if( Result != COMM_RXSUCCESS )
{
    printf( "Failed to write!\n" );
    printf( "Press any key to terminate...\n" );
    _getch();
    return 0;
}
else
{
    if(ErrorStatus != 0 )
        PrintErrorCode(ErrorStatus);
    else
        printf("Succeed to chage the operationg mode!\n");
}

printf("Press any key to terminate...\n" );
printf("\n");

```

```

while(true)
{
    if(_kbhit())
        break;

    unsigned char data[8];
    dxl_read(Port, ID, P_PRESENT_POSITION, 8, data, &ErrorStatus);

    int present_position, present_velocity;
    present_position = DXL_MAKEDWORD( DXL_MAKEWORD(data[0], data[1]),
DXL_MAKEWORD(data[2], data[3]) );
    present_velocity = DXL_MAKEDWORD( DXL_MAKEWORD(data[4], data[5]),
DXL_MAKEWORD(data[6], data[7]) );

    printf("\r");
    printf("present position : %d, present velocity : %d", present_position,
present_velocity);
}
printf("\n");

//Close the port of USB2DXL
printf( "Press any key to terminate...\n" );
_getch();

//Torque Off
printf( "Torque Off...\n" );
Result = dxl_write_byte(Port, ID, P_TORQUE_ENABLE, 0, &ErrorStatus);
if( Result != COMM_RXSUCCESS )
{
    printf( "Failed to write!\n" );
    printf( "Press any key to terminate...\n" );
    _getch();
    return 0;
}

dxl_terminate(Port);
return 0;
}

```

1.2.3 C programming language functions.

i. Modifying the zero value of Dynamixel PRO

- You can modify the zero-position of Dynamixel PRO.
- Change the Control table's Homing Offset to modify Dynamixel PRO's zero-position.
- Homing Offset address on the Control Tables is 13 and requires 4 bytes of memory. Therefore, implement `dxl_write_dword` to modify the Homing Offset value.
- Homing Offset is a part of the EEPROM area, which requires the Torque Enable to be turned off before changes.
- When modifying the Homing Offset value, designate the zero position by inverting the desired zero position with a negative sign (-).
- For instance, to set the Position Value 50000 as the zero position, -50000 needs to be entered as the Homing Offset value.
- The program's entire source code is shown below.
- Check if the Operation Mode is set as 'Joint Mode' before running the program below.

main.cpp

```

#include <stdio.h>
#include <conio.h>
#include "dynamixel.h"

#define COM_PORT_NUM          17      //Comport Number of USB2DXL
#define BAUD_RATE_NUM        3       //Baudrate Number of Dynamixel PRO

#define P_HOMING_OFFSET      13      //Address of Homing Offset in Control Table
#define P_TORQUE_ENABLE      562    //Address of Torque Enable in Control Table
#define P_GOAL_POSITION      596    //Address of Goal Position in Control Table

#define ID                    1      //ID of Dynamixel PRO you use

// Print error bit of status packet
void PrintErrorCode(int ErrorCode)
{
    if(ErrorCode & ERRCODE_VOLTAGE)
        printf("Input voltage error!\n");

    if(ErrorCode & ERRCODE_ANGLE)
        printf("Angle limit error!\n");

    if(ErrorCode & ERRCODE_OVERHEAT)
        printf("Overheat error!\n");

    if(ErrorCode & ERRCODE_RANGE)
        printf("Out of range error!\n");

    if(ErrorCode & ERRCODE_CHECKSUM)

```

```

        printf("Checksum error!\n");

    if(ErrorCode & ERROVERLOAD)
        printf("Overload error!\n");

    if(ErrorCode & ERRINSTRUCTION)
        printf("Instruction code error!\n");
}

int main(void)
{
    SerialPort sp = {0,0,0,0};
    SerialPort *Port = &sp;

    //Open the port of USB2DXL
    if(dx1_initialize(Port, COM_PORT_NUM, BAUD_RATE_NUM) == COMM_RXSUCCESS )
        printf("Succeed to open USB2Dynamixel!\n");
    else
    {
        printf( "Failed to open USB2Dynamixel!\n" );
        printf( "Press any key to terminate...\n" );
        _getch();
        return 0;
    }

    int Result, ErrorStatus;

    //Torque Off
    printf( "Torque Off...\n" );
    Result = dx1_write_byte(Port, ID, P_TORQUE_ENABLE, 0, &ErrorStatus);
    if( Result != COMM_RXSUCCESS )
    {
        printf( "Failed to write!\n" );
        printf( "Press any key to terminate...\n" );
        _getch();
        return 0;
    }

    //Change the zero point
    printf("Press any key to change the zero point...\n");
    _getch();
    Result = dx1_write_dword(Port, ID, P_HOMING_OFFSET, -50000, &ErrorStatus);
    if( Result != COMM_RXSUCCESS )
    {
        printf( "Failed to write!\n" );
        printf( "Press any key to terminate...\n" );
        _getch();
        return 0;
    }
    else

```

```

    {
        if(ErrorStatus != 0 )
            PrintErrorCode(ErrorStatus);
        else
            printf("Succeed to chage the homing offset!\n");
    }

    //Torque On
    printf( "Torque On...\n" );
    Result = dxl_write_byte(Port, ID, P_TORQUE_ENABLE, 1, &ErrorStatus);
    if( Result != COMM_RXSUCCESS )
    {
        printf( "Failed to write!\n" );
        printf( "Press any key to terminate...\n" );
        _getch();
        return 0;
    }

    //Change the Goal position
    printf("Press any key to change the Goal Position...\n");
    _getch();
    Result = dxl_write_dword(Port, ID, P_GOAL_POSITION, 0, &ErrorStatus);
    if( Result != COMM_RXSUCCESS )
    {
        printf( "Failed to write!\n" );
        printf( "Press any key to terminate...\n" );
        _getch();
        return 0;
    }
    else
        PrintErrorCode(ErrorStatus);

    //Close the port of USB2DXL
    printf( "Press any key to terminate...\n" );
    _getch();
    dxl_terminate(Port);
    return 0;
}

```

- If the program does not run properly check if the Operating Mode is set to Joint Mode.

ii. Limiting the operating range of Dynamixel PRO

- Please refer to 1.1 for information regarding +, - Position Limit.
- The program's entire source code is shown below.

```

main.cpp
#include <stdio.h>
#include <conio.h>
#include "dynamixel.h"

#define COM_PORT_NUM          17      //Comport Number of USB2DXL
#define BAUD_RATE_NUM        3       //Baudrate Number of Dynamixel PRO

#define P_PLUS_POSITION_LIMIT 36     //Address of Plus Position Limit in Control Table
#define P_MINUS_POSITION_LIMIT 40   //Address of Minus Position Limit in Control
Table
#define P_TORQUE_ENABLE      562    //Address of Torque Enable in Control Table
#define P_GOAL_POSITION      596    //Address of Goal Position in Control Table

#define ID                    1      //ID of Dynamixel PRO you use

// Print error bit of status packet
void PrintErrorCode(int ErrorCode)
{
    if(ErrorCode & ERRCODE_VOLTAGE)
        printf("Input voltage error!\n");

    if(ErrorCode & ERRCODE_ANGLE)
        printf("Angle limit error!\n");

    if(ErrorCode & ERRCODE_OVERHEAT)
        printf("Overheat error!\n");

    if(ErrorCode & ERRCODE_RANGE)
        printf("Out of range error!\n");

    if(ErrorCode & ERRCODE_CHECKSUM)
        printf("Checksum error!\n");

    if(ErrorCode & ERRCODE_OVERLOAD)
        printf("Overload error!\n");

    if(ErrorCode & ERRCODE_INSTRUCTION)
        printf("Instruction code error!\n");
}

int main(void)
{
    SerialPort sp = {0,0,0,0,0};
    SerialPort *Port = &sp;

```

```

//Open the port of USB2DXL
if(dx1_initialize(Port, COM_PORT_NUM, BAUD_RATE_NUM) == COMM_RXSUCCESS )
    printf("Succeed to open USB2Dynamixel!\n");
else
{
    printf("Failed to open USB2Dynamixel!\n");
    printf("Press any key to terminate...\n");
    _getch();
    return 0;
}

int Result, ErrorStatus;

//Torque Off
printf("Torque Off...\n");
Result = dx1_write_byte(Port, ID, P_TORQUE_ENABLE, 0, &ErrorStatus);
if( Result != COMM_RXSUCCESS )
{
    printf("Failed to write!\n");
    printf("Press any key to terminate...\n");
    _getch();
    return 0;
}

//Change the Plus Position Limit
printf("Press any key to change the plus position limit...\n");
_getch();
Result = dx1_write_dword(Port, ID, P_PLUS_POSITION_LIMIT, 100000, &ErrorStatus);
if( Result != COMM_RXSUCCESS )
{
    printf("Failed to write!\n");
    printf("Press any key to terminate...\n");
    _getch();
    return 0;
}
else
{
    if(ErrorStatus != 0 )
        PrintErrorCode(ErrorStatus);
    else
        printf("Succeed to chage the plus position limit!\n");
}

//Change the Minus Position Limit
printf("Press any key to change the minus position limit...\n");
_getch();
Result = dx1_write_dword(Port, ID, P_MINUS_POSITION_LIMIT, -100000, &ErrorStatus);
if( Result != COMM_RXSUCCESS )
{

```



```

        printf( "Failed to write!\n" );
        printf( "Press any key to terminate...\n" );
        _getch();
        return 0;
    }
else
{
    if(ErrorStatus != 0 )
        PrintErrorCode(ErrorStatus);
    else
        printf("Succeed to chage the minus position limit!\n");
}

//Torque On
printf( "Torque On...\n" );
Result = dxl_write_byte(Port, ID, P_TORQUE_ENABLE, 1, &ErrorStatus);
if( Result != COMM_RXSUCCESS )
{
    printf( "Failed to write!\n" );
    printf( "Press any key to terminate...\n" );
    _getch();
    return 0;
}

//Change the Goal position
printf("Press any key to change the Goal Position to 120000...\n");
_getch();
Result = dxl_write_dword(Port, ID, P_GOAL_POSITION, 120000, &ErrorStatus);
if( Result != COMM_RXSUCCESS )
{
    printf( "Failed to write!\n" );
    printf( "Press any key to terminate...\n" );
    _getch();
    return 0;
}
else
    PrintErrorCode(ErrorStatus);

//Change the Goal position
printf("Press any key to change the Goal Position to 100000\n");
_getch();
Result = dxl_write_dword(Port, ID, P_GOAL_POSITION, 100000, &ErrorStatus);
if( Result != COMM_RXSUCCESS )
{
    printf( "Failed to write!\n" );
    printf( "Press any key to terminate...\n" );
    _getch();
    return 0;
}
}

```

```

else
    PrintErrorCode(ErrorStatus);

//Change the Goal position
printf("Press any key to change the Goal Position to -120000\n");
_getch();
Result = dxl_write_dword(Port, ID, P_GOAL_POSITION, -120000, &ErrorStatus);
if( Result != COMM_RXSUCCESS )
{
    printf( "Failed to write!\n" );
    printf( "Press any key to terminate...\n" );
    _getch();
    return 0;
}
else
    PrintErrorCode(ErrorStatus);

//Change the Goal position
printf("Press any key to change the Goal Position to -100000\n");
_getch();
Result = dxl_write_dword(Port, ID, P_GOAL_POSITION, -100000, &ErrorStatus);
if( Result != COMM_RXSUCCESS )
{
    printf( "Failed to write!\n" );
    printf( "Press any key to terminate...\n" );
    _getch();
    return 0;
}
else
    PrintErrorCode(ErrorStatus);

//Close the port of USB2DXL
printf( "Press any key to terminate...\n" );
_getch();
dxl_terminate(Port);
return 0;
}

```

- If the program does not run properly check if the Operating Mode is set to Joint Mode.

iii. Extending the operating range of Dynamixel PRO.

- Please refer to 1.1 for information regarding +/- Position Limits.
- The program's entire source code is shown below.

```

main.cpp
#include <stdio.h>
#include <conio.h>
#include "dynamixel.h"

#define COM_PORT_NUM          17      //Comport Number of USB2DXL
#define BAUD_RATE_NUM        3       //Baudrate Number of Dynamixel PRO

#define P_PLUS_POSITION_LIMIT 36     //Address of Plus Position Limit in Control Table
#define P_MINUS_POSITION_LIMIT 40   //Address of Minus Position Limit in Control Table
#define P_TORQUE_ENABLE       562   //Address of Torque Enable in Control Table
#define P_GOAL_POSITION       596   //Address of Goal Position in Control Table

#define ID                    1      //ID of Dynamixel PRO you use

// Print error bit of status packet
void PrintErrorCode(int ErrorCode)
{
    if(ErrorCode & ERRCODE_VOLTAGE)
        printf("Input voltage error!\n");

    if(ErrorCode & ERRCODE_ANGLE)
        printf("Angle limit error!\n");

    if(ErrorCode & ERRCODE_OVERHEAT)
        printf("Overheat error!\n");

    if(ErrorCode & ERRCODE_RANGE)
        printf("Out of range error!\n");

    if(ErrorCode & ERRCODE_CHECKSUM)
        printf("Checksum error!\n");

    if(ErrorCode & ERRCODE_OVERLOAD)
        printf("Overload error!\n");

    if(ErrorCode & ERRCODE_INSTRUCTION)
        printf("Instruction code error!\n");
}

int main(void)
{
    SerialPort sp = {0,0,0,0,0};
    SerialPort *Port = &sp;

```

```

//Open the port of USB2DXL
if(dx1_initialize(Port, COM_PORT_NUM, BAUD_RATE_NUM) == COMM_RXSUCCESS )
    printf("Succeed to open USB2Dynamixel!\n");
else
{
    printf( "Failed to open USB2Dynamixel!\n" );
    printf( "Press any key to terminate...\n" );
    _getch();
    return 0;
}

int Result, ErrorStatus;

//Torque Off
printf( "Torque Off...\n" );
Result = dx1_write_byte(Port, ID, P_TORQUE_ENABLE, 0, &ErrorStatus);
if( Result != COMM_RXSUCCESS )
{
    printf( "Failed to write!\n" );
    printf( "Press any key to terminate...\n" );
    _getch();
    return 0;
}

//Change the Plus Position Limit
printf("Press any key to change the plus position limit...\n");
_getch();
Result = dx1_write_dword(Port, ID, P_PLUS_POSITION_LIMIT, 500000, &ErrorStatus);
if( Result != COMM_RXSUCCESS )
{
    printf( "Failed to write!\n" );
    printf( "Press any key to terminate...\n" );
    _getch();
    return 0;
}
else
{
    if(ErrorStatus != 0 )
        PrintErrorCode(ErrorStatus);
    else
        printf("Succeed to chage the plus position limit!\n");
}

//Change the Minus Position Limit
printf("Press any key to change the minus position limit...\n");
_getch();
Result = dx1_write_dword(Port, ID, P_MINUS_POSITION_LIMIT, -500000, &ErrorStatus);
if( Result != COMM_RXSUCCESS )
{
    printf( "Failed to write!\n" );

```

```

        printf( "Press any key to terminate...\n" );
        _getch();
        return 0;
    }
    else
    {
        if(ErrorStatus != 0 )
            PrintErrorCode(ErrorStatus);
        else
            printf("Succeed to chage the minus position limit!\n");
    }

//Torque On
printf( "Torque On...\n" );
Result = dxl_write_byte(Port, ID, P_TORQUE_ENABLE, 1, &ErrorStatus);
if( Result != COMM_RXSUCCESS )
{
    printf( "Failed to write!\n" );
    printf( "Press any key to terminate...\n" );
    _getch();
    return 0;
}

//Change the Goal position
printf("Press any key to change the Goal Position to 500000...\n");
_getch();
Result = dxl_write_dword(Port, ID, P_GOAL_POSITION, 500000, &ErrorStatus);
if( Result != COMM_RXSUCCESS )
{
    printf( "Failed to write!\n" );
    printf( "Press any key to terminate...\n" );
    _getch();
    return 0;
}
else
    PrintErrorCode(ErrorStatus);

//Change the Goal position
printf("Press any key to change the Goal Position to -500000\n");
_getch();
Result = dxl_write_dword(Port, ID, P_GOAL_POSITION, -500000, &ErrorStatus);
if( Result != COMM_RXSUCCESS )
{
    printf( "Failed to write!\n" );
    printf( "Press any key to terminate...\n" );
    _getch();
    return 0;
}
else
    PrintErrorCode(ErrorStatus);

```

```
//Close the port of USB2DXL
printf( "Press any key to terminate...\n" );
_getch();
dxl_terminate(Port);
return 0;
}
```

- If the program does not run properly check if the Operating Mode is set to Joint Mode.

1.2.4 Indirect Addressing function of Dynamixel PRO

- i. Change the position, velocity, and acceleration using Indirect Address function.
 - On Dynamixel PRO's Control Table-Goal Position, Goal Velocity, and Goal Acceleration addresses-are not arranged in consecutive order. Thus, **dxl_write** and **dxl_write_dword** need to be implemented 3 times to change all 3 addresses.
 - To resolve this issue, Dynamixel PRO has Indirect Address function.
 - Indirect Address assigns another address to the default one.
 - For example, Goal Position (#596) address can be assigned another address (#634).
 - Start by writing the value of the desired address in the EEPROM area of the Indirect Address.
 - The written value is the default address. Please refer to the source code below

```

dxl_write_word(Port, ID, P_INDIRECT_ADDRESS_0, P_GOAL_POSITION, &ErrorStatus);
dxl_write_word(Port, ID, P_INDIRECT_ADDRESS_1, P_GOAL_POSITION+1, &ErrorStatus);
dxl_write_word(Port, ID, P_INDIRECT_ADDRESS_2, P_GOAL_POSITION+2, &ErrorStatus);
dxl_write_word(Port, ID, P_INDIRECT_ADDRESS_3, P_GOAL_POSITION+3, &ErrorStatus);
dxl_write_word(Port, ID, P_INDIRECT_ADDRESS_4, P_GOAL_VELOCITY, &ErrorStatus);
dxl_write_word(Port, ID, P_INDIRECT_ADDRESS_5, P_GOAL_VELOCITY+1, &ErrorStatus);
dxl_write_word(Port, ID, P_INDIRECT_ADDRESS_6, P_GOAL_VELOCITY+2, &ErrorStatus);
dxl_write_word(Port, ID, P_INDIRECT_ADDRESS_7, P_GOAL_VELOCITY+3, &ErrorStatus);
dxl_write_word(Port, ID, P_INDIRECT_ADDRESS_8, P_GOAL_ACCELERATION,
&ErrorStatus);
dxl_write_word(Port, ID, P_INDIRECT_ADDRESS_9, P_GOAL_ACCELERATION+1,
&ErrorStatus);
dxl_write_word(Port, ID, P_INDIRECT_ADDRESS_10, P_GOAL_ACCELERATION+2,
&ErrorStatus);
dxl_write_word(Port, ID, P_INDIRECT_ADDRESS_11, P_GOAL_ACCELERATION+3,
&ErrorStatus);
    
```

- The program's entire source code is shown below.

```

main.cpp
#include <stdio.h>
#include <conio.h>
#include "dynamixel.h"

#define COM_PORT_NUM          17      //Comport Number of USB2DXL
#define BAUD_RATE_NUM        3       //Baudrate Number of Dynamixel PRO

#define P_INDIRECT_ADDRESS_0  49     //Address of 1st Indirect Address in Control
Table
#define P_INDIRECT_ADDRESS_1  51     //Address of 2nd Indirect Address in Control
Table
#define P_INDIRECT_ADDRESS_2  53     //Address of 3rd Indirect Address in Control
Table
#define P_INDIRECT_ADDRESS_3  55     //Address of 4th Indirect Address in Control
Table
#define P_INDIRECT_ADDRESS_4  57     //Address of 5th Indirect Address in Control
    
```

```

Table
#define P_INDIRECT_ADDRESS_5 59 //Address of 6th Indirect Address in Control
Table
#define P_INDIRECT_ADDRESS_6 61 //Address of 7th Indirect Address in Control
Table
#define P_INDIRECT_ADDRESS_7 63 //Address of 8th Indirect Address in Control
Table
#define P_INDIRECT_ADDRESS_8 65 //Address of 9th Indirect Address in Control
Table
#define P_INDIRECT_ADDRESS_9 67 //Address of 10th Indirect Address in Control
Table
#define P_INDIRECT_ADDRESS_10 69 //Address of 11th Indirect Address in Control
Table
#define P_INDIRECT_ADDRESS_11 71 //Address of 12th Indirect Address in Control
Table

#define P_TORQUE_ENABLE 562 //Address of Torque Enable in Control Table
#define P_GOAL_POSITION 596 //Address of Goal Position in Control Table
#define P_GOAL_VELOCITY 600 //Address of Goal Velocity in Control Table
#define P_GOAL_ACCELERATION 606 //Address of Goal Acceleration in Control
Table
#define P_INDIRECT_DATA_0 634 //Address of Goal Indirect Data in Control Table

#define ID 1 //ID of Dynamixel PRO you use

// Print error bit of status packet
void PrintErrorCode(int ErrorCode)
{
    if(ErrorCode & ERBBIT_VOLTAGE)
        printf("Input voltage error!\n");

    if(ErrorCode & ERBBIT_ANGLE)
        printf("Angle limit error!\n");

    if(ErrorCode & ERBBIT_OVERHEAT)
        printf("Overheat error!\n");

    if(ErrorCode & ERBBIT_RANGE)
        printf("Out of range error!\n");

    if(ErrorCode & ERBBIT_CHECKSUM)
        printf("Checksum error!\n");

    if(ErrorCode & ERBBIT_OVERLOAD)
        printf("Overload error!\n");

    if(ErrorCode & ERBBIT_INSTRUCTION)
        printf("Instruction code error!\n");
}

```



```

int main(void)
{
    SerialPort sp = {0,0,0,0,0};
    SerialPort *Port = &sp;

    //Open the port of USB2DXL
    if(dx1_initialize(Port, COM_PORT_NUM, BAUD_RATE_NUM) == COMM_RXSUCCESS )
        printf("Succeed to open USB2Dynamixel!\n");
    else
    {
        printf( "Failed to open USB2Dynamixel!\n" );
        printf( "Press any key to terminate...\n" );
        _getch();
        return 0;
    }

    int Result, ErrorStatus;

    //Torque Off
    printf( "Torque Off...\n" );
    Result = dx1_write_byte(Port, ID, P_TORQUE_ENABLE, 0, &ErrorStatus);
    if( Result != COMM_RXSUCCESS )
    {
        printf( "Failed to write!\n" );
        printf( "Press any key to terminate...\n" );
        _getch();
        return 0;
    }

    //Set the Indirect Address for Goal Position
    printf("Press any key to set the indirect address for goal position...\n");
    _getch();
    Result = dx1_write_word(Port, ID, P_INDIRECT_ADDRESS_0, P_GOAL_POSITION,
&ErrorStatus);
    Result = dx1_write_word(Port, ID, P_INDIRECT_ADDRESS_1, P_GOAL_POSITION+1,
&ErrorStatus);
    Result = dx1_write_word(Port, ID, P_INDIRECT_ADDRESS_2, P_GOAL_POSITION+2,
&ErrorStatus);
    Result = dx1_write_word(Port, ID, P_INDIRECT_ADDRESS_3, P_GOAL_POSITION+3,
&ErrorStatus);
    if( Result != COMM_RXSUCCESS )
    {
        printf( "Failed to write!\n" );
        printf( "Press any key to terminate...\n" );
        _getch();
        return 0;
    }
    else
    {
        if(ErrorStatus != 0 )

```

```

        PrintErrorCode(ErrorStatus);
    else
        printf("Succeed to set the indirect address for goal position!\n");
}

//Set the Indirect Address for Goal Velocity
printf("Press any key to set the indirect address for goal velocity...\n");
_getch();
Result = dxl_write_word(Port, ID, P_INDIRECT_ADDRESS_4, P_GOAL_VELOCITY,
&ErrorStatus);
Result = dxl_write_word(Port, ID, P_INDIRECT_ADDRESS_5, P_GOAL_VELOCITY+1,
&ErrorStatus);
Result = dxl_write_word(Port, ID, P_INDIRECT_ADDRESS_6, P_GOAL_VELOCITY+2,
&ErrorStatus);
Result = dxl_write_word(Port, ID, P_INDIRECT_ADDRESS_7, P_GOAL_VELOCITY+3,
&ErrorStatus);
if( Result != COMM_RXSUCCESS )
{
    printf( "Failed to write!\n" );
    printf( "Press any key to terminate...\n" );
    _getch();
    return 0;
}
else
{
    if(ErrorStatus != 0 )
        PrintErrorCode(ErrorStatus);
    else
        printf("Succeed to set the indirect address for goal velocity!\n");
}

//Set the Indirect Address for Goal Acceleration
printf("Press any key to set the indirect address for goal acceleration...\n");
_getch();
Result = dxl_write_word(Port, ID, P_INDIRECT_ADDRESS_8,
P_GOAL_ACCELERATION, &ErrorStatus);
Result = dxl_write_word(Port, ID, P_INDIRECT_ADDRESS_9,
P_GOAL_ACCELERATION+1, &ErrorStatus);
Result = dxl_write_word(Port, ID, P_INDIRECT_ADDRESS_10,
P_GOAL_ACCELERATION+2, &ErrorStatus);
Result = dxl_write_word(Port, ID, P_INDIRECT_ADDRESS_11,
P_GOAL_ACCELERATION+3, &ErrorStatus);
if( Result != COMM_RXSUCCESS )
{
    printf( "Failed to write!\n" );
    printf( "Press any key to terminate...\n" );
    _getch();
    return 0;
}
else

```

```

    {
        if(ErrorStatus != 0 )
            PrintErrorCode(ErrorStatus);
        else
            printf("Succeed to set the indirect address for goal acceleration!\n");
    }

//Torque On
printf( "Torque On...\n" );
Result = dxl_write_byte(Port, ID, P_TORQUE_ENABLE, 1, &ErrorStatus);
if( Result != COMM_RXSUCCESS )
{
    printf( "Failed to write!\n" );
    printf( "Press any key to terminate...\n" );
    _getch();
    return 0;
}

int position, velocity, acceleration;
position = 100000;
velocity = 10000;
acceleration = 16;

//Make a tx data
unsigned char data[12];
data[0] = DXL_LOBYTE(DXL_LOWORD(position));
data[1] = DXL_HIBYTE(DXL_LOWORD(position));
data[2] = DXL_LOBYTE(DXL_HIWORD(position));
data[3] = DXL_HIBYTE(DXL_HIWORD(position));
data[4] = DXL_LOBYTE(DXL_LOWORD(velocity));
data[5] = DXL_HIBYTE(DXL_LOWORD(velocity));
data[6] = DXL_LOBYTE(DXL_HIWORD(velocity));
data[7] = DXL_HIBYTE(DXL_HIWORD(velocity));
data[8] = DXL_LOBYTE(DXL_LOWORD(acceleration));
data[9] = DXL_HIBYTE(DXL_LOWORD(acceleration));
data[10] = DXL_LOBYTE(DXL_HIWORD(acceleration));
data[11] = DXL_HIBYTE(DXL_HIWORD(acceleration));

//change the position value, moving speed, acceleration using indirect addr
printf( "Press any key to change the position, speed, acceleration...\n" );
_getch();
Result = dxl_write(Port, ID, P_INDIRECT_DATA_0, 12, data, &ErrorStatus);
if( Result != COMM_RXSUCCESS )
{
    printf( "Failed to write!\n" );
    printf( "Press any key to terminate...\n" );
    _getch();
    return 0;
}

```

```

else
{
    if(ErrorStatus != 0 )
        PrintErrorCode(ErrorStatus);
}

position = -100000;
velocity = 1000;
acceleration = 2;

//Make a tx data
data[0] = DXL_LOBYTE(DXL_LOWORD(position));
data[1] = DXL_HIBYTE(DXL_LOWORD(position));
data[2] = DXL_LOBYTE(DXL_HIWORD(position));
data[3] = DXL_HIBYTE(DXL_HIWORD(position));
data[4] = DXL_LOBYTE(DXL_LOWORD(velocity));
data[5] = DXL_HIBYTE(DXL_LOWORD(velocity));
data[6] = DXL_LOBYTE(DXL_HIWORD(velocity));
data[7] = DXL_HIBYTE(DXL_HIWORD(velocity));
data[8] = DXL_LOBYTE(DXL_LOWORD(acceleration));
data[9] = DXL_HIBYTE(DXL_LOWORD(acceleration));
data[10] = DXL_LOBYTE(DXL_HIWORD(acceleration));
data[11] = DXL_HIBYTE(DXL_HIWORD(acceleration));

//change the position value, moving speed, acceleration using indirect addr
printf( "Press any key to change the position, speed, acceleration...\n" );
_getch();
Result = dxl_write(Port, ID, P_INDIRECT_DATA_0, 12, data, &ErrorStatus);
if( Result != COMM_RXSUCCESS )
{
    printf( "Failed to write!\n" );
    printf( "Press any key to terminate...\n" );
    _getch();
    return 0;
}
else
{
    if(ErrorStatus != 0 )
        PrintErrorCode(ErrorStatus);
}

//Close the port of USB2DXL
printf( "Press any key to terminate...\n" );
_getch();
dxl_terminate(Port);
return 0;
}

```

ii. Reading the temperature and the current position using Indirect Address

- Implement Indirect Address to obtain read outputs.
- Read the Present Position and Present Temperature by using Indirect Address.
- The program's entire source code is shown below.

```
main.cpp
```

```
#include <stdio.h>
#include <conio.h>
#include "dynamixel.h"

#define COM_PORT_NUM          17      //Comport Number of USB2DXL
#define BAUD_RATE_NUM        3       //Baudrate Number of Dynamixel PRO

#define P_OPERATING_MODE     11      //Address of Operating Mode in Control Table
#define P_INDIRECT_ADDRESS_0 49      //Address of 1st Indirect Address in Control Table
#define P_INDIRECT_ADDRESS_1 51      //Address of 2nd Indirect Address in Control Table
#define P_INDIRECT_ADDRESS_2 53      //Address of 3rd Indirect Address in Control Table
#define P_INDIRECT_ADDRESS_3 55      //Address of 4th Indirect Address in Control Table
#define P_INDIRECT_ADDRESS_4 57      //Address of 5th Indirect Address in Control Table

#define P_TORQUE_ENABLE      562     //Address of Torque Enable in Control Table
#define P_PRESENT_POSITION   611     //Address of Present Position in Control Table
#define P_PRESENT_TEMPERATURE 625    //Address of Present Temperature in Control Table

#define P_INDIRECT_DATA_0    634     //Address of Goal Indirect Data in Control Table

#define ID                    1      //ID of Dynamixel PRO you use

// Print error bit of status packet
void PrintErrorCode(int ErrorCode)
{
    if(ErrorCode & ERBIT_VOLTAGE)
        printf("Input voltage error!\n");

    if(ErrorCode & ERBIT_ANGLE)
        printf("Angle limit error!\n");

    if(ErrorCode & ERBIT_OVERHEAT)
        printf("Overheat error!\n");

    if(ErrorCode & ERBIT_RANGE)
        printf("Out of range error!\n");
}
```

```

    if(ErrorCode & ERRCODE_CHECKSUM)
        printf("Checksum error!\n");

    if(ErrorCode & ERRCODE_OVERLOAD)
        printf("Overload error!\n");

    if(ErrorCode & ERRCODE_INSTRUCTION)
        printf("Instruction code error!\n");
}

int main(void)
{
    SerialPort sp = {0,0,0,0,0};
    SerialPort *Port = &sp;

    //Open the port of USB2DXL
    if(dx1_initialize(Port, COM_PORT_NUM, BAUD_RATE_NUM) ==
COMM_RXSUCCESS )
        printf("Succeed to open USB2Dynamixel!\n");
    else
    {
        printf( "Failed to open USB2Dynamixel!\n" );
        printf( "Press any key to terminate...\n" );
        _getch();
        return 0;
    }

    int Result, ErrorStatus;

    //Torque Off
    printf( "Torque Off...\n" );
    Result = dx1_write_byte(Port, ID, P_TORQUE_ENABLE, 0, &ErrorStatus);
    if( Result != COMM_RXSUCCESS )
    {
        printf( "Failed to write!\n" );
        printf( "Press any key to terminate...\n" );
        _getch();
        return 0;
    }

    //change the operating mode to wheel mode
    printf( "Make the Mode of Dynamixel PRO to Wheel Mode...\n" );
    Result = dx1_write_byte(Port, ID, P_OPERATING_MODE, 1, &ErrorStatus);
    if( Result != COMM_RXSUCCESS )
    {
        printf( "Failed to write!\n" );
        printf( "Press any key to terminate...\n" );
        _getch();
        return 0;
    }
}

```

```

//Set the Indirect Address for Present Temperature
printf("Press any key to set the indirect address for temperature...\n");
_getch();
Result = dxl_write_word(Port, ID, P_INDIRECT_ADDRESS_0,
P_PRESENT_TEMPERATURE, &ErrorStatus);
if( Result != COMM_RXSUCCESS )
{
    printf( "Failed to write!\n" );
    printf( "Press any key to terminate...\n" );
    _getch();
    return 0;
}
else
{
    if(ErrorStatus != 0 )
        PrintErrorCode(ErrorStatus);
    else
        printf("Succeed to set the indirect address for temperature!\n");
}

//Set the Indirect Address for Goal Velocity
printf("Press any key to set the indirect address for present position...\n");
_getch();
Result = dxl_write_word(Port, ID, P_INDIRECT_ADDRESS_1, P_PRESENT_POSITION,
&ErrorStatus);
Result = dxl_write_word(Port, ID, P_INDIRECT_ADDRESS_2,
P_PRESENT_POSITION+1, &ErrorStatus);
Result = dxl_write_word(Port, ID, P_INDIRECT_ADDRESS_3,
P_PRESENT_POSITION+2, &ErrorStatus);
Result = dxl_write_word(Port, ID, P_INDIRECT_ADDRESS_4,
P_PRESENT_POSITION+3, &ErrorStatus);
if( Result != COMM_RXSUCCESS )
{
    printf( "Failed to write!\n" );
    printf( "Press any key to terminate...\n" );
    _getch();
    return 0;
}
else
{
    if(ErrorStatus != 0 )
        PrintErrorCode(ErrorStatus);
    else
        printf("Succeed to set the indirect address for present position!\n");
}

//Torque On
printf( "Torque On...\n" );

```

```

Result = dxl_write_byte(Port, ID, P_TORQUE_ENABLE, 1, &ErrorStatus);
if( Result != COMM_RXSUCCESS )
{
    printf( "Failed to write!\n" );
    printf( "Press any key to terminate...\n" );
    _getch();
    return 0;
}

//Rotating Start
printf("Rotating Start\n");
Result = dxl_write_dword(Port, ID, 600, 5000, &ErrorStatus);
if( Result != COMM_RXSUCCESS )
{
    printf( "Failed to write!\n" );
    printf( "Press any key to terminate...\n" );
    _getch();
    return 0;
}

printf("Press any key to terminate...\n" );
printf("\n");
while(true)
{
    if(_kbhit())
        break;

    unsigned char data[5];
    dxl_read(Port, ID, P_INDIRECT_DATA_0, 5, data, &ErrorStatus);

    int temp, present_position;
    temp = data[0];
    present_position = DXL_MAKEDWORD( DXL_MAKEWORD(data[1], data[2]),
DXL_MAKEWORD(data[3], data[4]) );

    printf("\r");
    printf("present temperature : %d, present position : %d", temp, present_position);
}
printf("\n");

//Close the port of USB2DXL
dxl_terminate(Port);
return 0;
}

```

1.2.5 Using Multiple Dynamixel PROs

i. Controlling the LEDs of 3 Dynamixel PROs

- Implement `dxl_synch_write` to simultaneously send a command to multiple Dynamixel PROs.
- The program's entire source code is shown below.

```
main.cpp
#include <stdio.h>
#include <conio.h>
#include "dynamixel.h"

#define COM_PORT_NUM          17      //Comport Number of USB2DXL
#define BAUD_RATE_NUM        3       //Baudrate Number of Dynamixel PRO

#define P_LED_RED             563     //Address of LED RED in Control Table

#define ID_1                  1       //ID of Dynamixel PRO you use
#define ID_2                  2
#define ID_3                  3

// Print error bit of status packet
void PrintErrorCode(int ErrorCode)
{
    if(ErrorCode & ERRCODE_VOLTAGE)
        printf("Input voltage error!\n");

    if(ErrorCode & ERRCODE_ANGLE)
        printf("Angle limit error!\n");

    if(ErrorCode & ERRCODE_OVERHEAT)
        printf("Overheat error!\n");

    if(ErrorCode & ERRCODE_RANGE)
        printf("Out of range error!\n");

    if(ErrorCode & ERRCODE_CHECKSUM)
        printf("Checksum error!\n");

    if(ErrorCode & ERRCODE_OVERLOAD)
        printf("Overload error!\n");

    if(ErrorCode & ERRCODE_INSTRUCTION)
        printf("Instruction code error!\n");
}

int main(void)
{
    SerialPort sp = {0,0,0,0,0};
    SerialPort *Port = &sp;
```

```

//Open the port of USB2DXL
if(dx1_initialize(Port, COM_PORT_NUM, BAUD_RATE_NUM) ==
COMM_RXSUCCESS )
    printf("Succeed to open USB2Dynamixel!\n");
else
{
    printf("Failed to open USB2Dynamixel!\n" );
    printf("Press any key to terminate...\n" );
    _getch();
    return 0;
}

int Result;

unsigned char param[6];
param[0] = ID_1;
param[1] = 255;
param[2] = ID_2;
param[3] = 255;
param[4] = ID_3;
param[5] = 255;

//LED On
printf("Press any to turn on the LED...\n" );
_getch();
Result = dx1_sync_write(Port, P_LED_RED, 1, param, 6);
if( Result != COMM_RXSUCCESS )
{
    printf("Failed to write!\n" );
    printf("Press any key to terminate...\n" );
    _getch();
    return 0;
}

param[0] = ID_1;
param[1] = 0;
param[2] = ID_2;
param[3] = 0;
param[4] = ID_3;
param[5] = 0;

//LED Off
printf("Press any to turn off the LED...\n" );
_getch();
Result = dx1_sync_write(Port, P_LED_RED, 1, param, 6);
if( Result != COMM_RXSUCCESS )
{
    printf("Failed to write!\n" );
    printf("Press any key to terminate...\n" );
    _getch();
}

```

```
        return 0;
    }

    //Close the port of USB2DXL
    printf( "Press any key to terminate...\n" );
    _getch();
    dxl_terminate(Port);
    return 0;
}
```

ii. Controlling the Goal Position of 3 Dynamixel PRO

- The program's entire source code is shown below.

main.cpp

```

#include <stdio.h>
#include <conio.h>
#include "dynamixel.h"

#define COM_PORT_NUM          17      //Comport Number of USB2DXL
#define BAUD_RATE_NUM        3       //Baudrate Number of Dynamixel PRO

#define P_TORQUE_ENABLE      562     //Address of Torque Enable in Control Table
#define P_GOAL_POSITION      596     //Address of Goal Position in Control Table

#define ID_1                  1       //ID of Dynamixel PRO you use
#define ID_2                  2
#define ID_3                  3

// Print error bit of status packet
void PrintErrorCode(int ErrorCode)
{
    if(ErrorCode & ERRCODE_VOLTAGE)
        printf("Input voltage error!\n");

    if(ErrorCode & ERRCODE_ANGLE)
        printf("Angle limit error!\n");

    if(ErrorCode & ERRCODE_OVERHEAT)
        printf("Overheat error!\n");

    if(ErrorCode & ERRCODE_RANGE)
        printf("Out of range error!\n");

    if(ErrorCode & ERRCODE_CHECKSUM)
        printf("Checksum error!\n");

    if(ErrorCode & ERRCODE_OVERLOAD)
        printf("Overload error!\n");

    if(ErrorCode & ERRCODE_INSTRUCTION)
        printf("Instruction code error!\n");
}

int main(void)
{
    SerialPort sp = {0,0,0,0,0};
    SerialPort *Port = &sp;

    //Open the port of USB2DXL
    if(dxl_initialize(Port, COM_PORT_NUM, BAUD_RATE_NUM) ==

```

```

COMM_RXSUCCESS )
    printf("Succeed to open USB2Dynamixel!\n");
else
{
    printf("Failed to open USB2Dynamixel!\n");
    printf("Press any key to terminate...\n");
    _getch();
    return 0;
}

int Result;
unsigned char param[15];
//Torque ON
printf("Torque On\n");
param[0] = ID_1;
param[1] = 1;
param[2] = ID_2;
param[3] = 1;
param[4] = ID_3;
param[5] = 1;
Result = dxl_sync_write(Port, P_TORQUE_ENABLE, 1, param, 6);
if( Result != COMM_RXSUCCESS )
{
    printf("Failed to write!\n");
    printf("Press any key to terminate...\n");
    _getch();
    return 0;
}

param[0] = ID_1;
param[1] = DXL_LOBYTE(DXL_LOWORD(100000));
param[2] = DXL_HIBYTE(DXL_LOWORD(100000));
param[3] = DXL_LOBYTE(DXL_HIWORD(100000));
param[4] = DXL_HIBYTE(DXL_HIWORD(100000));
param[5] = ID_2;
param[6] = DXL_LOBYTE(DXL_LOWORD(50000));
param[7] = DXL_HIBYTE(DXL_LOWORD(50000));
param[8] = DXL_LOBYTE(DXL_HIWORD(50000));
param[9] = DXL_HIBYTE(DXL_HIWORD(50000));
param[10]= ID_3;
param[11]= DXL_LOBYTE(DXL_LOWORD(-80000));
param[12]= DXL_HIBYTE(DXL_LOWORD(-80000));
param[13]= DXL_LOBYTE(DXL_HIWORD(-80000));
param[14]= DXL_HIBYTE(DXL_HIWORD(-80000));

printf("Press any to change goal position...\n");
_getch();
Result = dxl_sync_write(Port, P_GOAL_POSITION, 4, param, 15);
if( Result != COMM_RXSUCCESS )

```

```

    {
        printf( "Failed to write!\n" );
        printf( "Press any key to terminate...\n" );
        _getch();
        return 0;
    }

param[0] = ID_1;
param[1] = DXL_LOBYTE(DXL_LOWORD(0));
param[2] = DXL_HIBYTE(DXL_LOWORD(0));
param[3] = DXL_LOBYTE(DXL_HIWORD(0));
param[4] = DXL_HIBYTE(DXL_HIWORD(0));
param[5] = ID_2;
param[6] = DXL_LOBYTE(DXL_LOWORD(0));
param[7] = DXL_HIBYTE(DXL_LOWORD(0));
param[8] = DXL_LOBYTE(DXL_HIWORD(0));
param[9] = DXL_HIBYTE(DXL_HIWORD(0));
param[10]= ID_3;
param[11]= DXL_LOBYTE(DXL_LOWORD(0));
param[12]= DXL_HIBYTE(DXL_LOWORD(0));
param[13]= DXL_LOBYTE(DXL_HIWORD(0));
param[14]= DXL_HIBYTE(DXL_HIWORD(0));

printf( "Press any to change goal position...\n" );
_getch();
Result = dxl_sync_write(Port, P_GOAL_POSITION, 4, param, 15);
if( Result != COMM_RXSUCCESS )
{
    printf( "Failed to write!\n" );
    printf( "Press any key to terminate...\n" );
    _getch();
    return 0;
}

//Close the port of USB2DXL
printf( "Press any key to terminate...\n" );
_getch();
dxl_terminate(Port);
return 0;
}

```

iii. Reading the the Current Position of 3 Dynamixel PROs

- Implement `dxl_bulk_read` to simultaneously read the values of multiple Dynamixel PROs.
- The program's entire source code is shown below.

```

main.cpp
#include <stdio.h>
#include <conio.h>
#include "dynamixel.h"

#define COM_PORT_NUM          17      //Comport Number of USB2DXL
#define BAUD_RATE_NUM        3       //Baudrate Number of Dynamixel PRO

#define P_PRESENT_POSITION    611    //Address of Goal Position in Control Table

#define ID_1                  1       //ID of Dynamixel PRO you use
#define ID_2                  2
#define ID_3                  3

// Print error bit of status packet
void PrintErrorCode(int ErrorCode)
{
    if(ErrorCode & ERRCODE_VOLTAGE)
        printf("Input voltage error!\n");

    if(ErrorCode & ERRCODE_ANGLE)
        printf("Angle limit error!\n");

    if(ErrorCode & ERRCODE_OVERHEAT)
        printf("Overheat error!\n");

    if(ErrorCode & ERRCODE_RANGE)
        printf("Out of range error!\n");

    if(ErrorCode & ERRCODE_CHECKSUM)
        printf("Checksum error!\n");

    if(ErrorCode & ERRCODE_OVERLOAD)
        printf("Overload error!\n");

    if(ErrorCode & ERRCODE_INSTRUCTION)
        printf("Instruction code error!\n");
}

int main(void)
{
    SerialPort sp = {0,0,0,0,0};
    SerialPort *Port = &sp;

    //Open the port of USB2DXL

```

```

    if(dx1_initialize(Port, COM_PORT_NUM, BAUD_RATE_NUM) ==
COMM_RXSUCCESS )
        printf("Succeed to open USB2Dynamixel!\n");
    else
    {
        printf( "Failed to open USB2Dynamixel!\n" );
        printf( "Press any key to terminate...\n" );
        _getch();
        return 0;
    }

    int Result;
    int position_length=4;
    unsigned char param[15];
    param[0] = ID_1;
    param[1] = DXL_LOBYTE(P_PRESENT_POSITION);
    param[2] = DXL_HIBYTE(P_PRESENT_POSITION);
    param[3] = DXL_LOBYTE(position_length);
    param[4] = DXL_HIBYTE(position_length);
    param[5] = ID_2;
    param[6] = DXL_LOBYTE(P_PRESENT_POSITION);
    param[7] = DXL_HIBYTE(P_PRESENT_POSITION);
    param[8] = DXL_LOBYTE(position_length);
    param[9] = DXL_HIBYTE(position_length);
    param[10] = ID_3;
    param[11] = DXL_LOBYTE(P_PRESENT_POSITION);
    param[12] = DXL_HIBYTE(P_PRESENT_POSITION);
    param[13] = DXL_LOBYTE(position_length);
    param[14] = DXL_HIBYTE(position_length);

    BulkData bd[256];
    BulkData *pbd[256];
    for(unsigned int i = 0 ; i <256 ; i++)
    {
        pbd[i] = &bd[i];
    }

    dx1_bulk_read(Port, param, 15, pbd);

    int present_position1;
    int present_position2;
    int present_position3;

    dx1_get_bulk_dword(pbd, ID_1, P_PRESENT_POSITION, (unsigned*)&present_position1);
    dx1_get_bulk_dword(pbd, ID_2, P_PRESENT_POSITION, (unsigned*)&present_position2);
    dx1_get_bulk_dword(pbd, ID_3, P_PRESENT_POSITION, (unsigned*)&present_position3);

    printf("Present Position\n");

```



```
printf("ID_1 : %d\n", present_position1);  
printf("ID_2 : %d\n", present_position2);  
printf("ID_3 : %d\n", present_position3);
```

```
//Close the port of USB2DXL
```

```
printf( "Press any key to terminate...\n" );  
_getch();  
dxl_terminate(Port);  
return 0;
```

```
}
```

- iv. Read temperature of the first, position of the second, and present current of the third Dynamixel PRO
- Implement `dxl_bulk_read` to simultaneously read the values of multiple Dynamixel PROs.
 - The program's entire source code is shown below.

```
main.cpp
#include <stdio.h>
#include <conio.h>
#include "dynamixel.h"

#define COM_PORT_NUM          17      //Comport Number of USB2DXL
#define BAUD_RATE_NUM        3       //Baudrate Number of Dynamixel PRO

#define P_PRESENT_POSITION   611     //Address of Goal Position in Control Table
#define P_PRESENT_CURRENT    621     //Address of Present Current in Control Table
#define P_PRESENT_TEMPERATURE 625    //Address of Present Temperature in Control Table

#define ID_1                  1      //ID of Dynamixel PRO you use
#define ID_2                  2
#define ID_3                  3

// Print error bit of status packet
void PrintErrorCode(int ErrorCode)
{
    if(ErrorCode & ERRCODE_VOLTAGE)
        printf("Input voltage error!\n");

    if(ErrorCode & ERRCODE_ANGLE)
        printf("Angle limit error!\n");

    if(ErrorCode & ERRCODE_OVERHEAT)
        printf("Overheat error!\n");

    if(ErrorCode & ERRCODE_RANGE)
        printf("Out of range error!\n");

    if(ErrorCode & ERRCODE_CHECKSUM)
        printf("Checksum error!\n");

    if(ErrorCode & ERRCODE_OVERLOAD)
        printf("Overload error!\n");

    if(ErrorCode & ERRCODE_INSTRUCTION)
        printf("Instruction code error!\n");
}

int main(void)
{
```

```

SerialPort sp = {0,0,0,0,0};
SerialPort *Port = &sp;

//Open the port of USB2DXL
if(dxl_initialize(Port, COM_PORT_NUM, BAUD_RATE_NUM) ==
COMM_RXSUCCESS )
    printf("Succeed to open USB2Dynamixel!\n");
else
{
    printf( "Failed to open USB2Dynamixel!\n" );
    printf( "Press any key to terminate...\n" );
    _getch();
    return 0;
}

int Result;
int current_length = 2, position_length = 4, temperature_length = 1;
unsigned char param[15];
param[0] = ID_1;
param[1] = DXL_LOBYTE(P_PRESENT_CURRENT);
param[2] = DXL_HIBYTE(P_PRESENT_CURRENT);
param[3] = DXL_LOBYTE(current_length);
param[4] = DXL_HIBYTE(current_length);
param[5] = ID_2;
param[6] = DXL_LOBYTE(P_PRESENT_POSITION);
param[7] = DXL_HIBYTE(P_PRESENT_POSITION);
param[8] = DXL_LOBYTE(position_length);
param[9] = DXL_HIBYTE(position_length);
param[10] = ID_3;
param[11] = DXL_LOBYTE(P_PRESENT_TEMPERATURE);
param[12] = DXL_HIBYTE(P_PRESENT_TEMPERATURE);
param[13] = DXL_LOBYTE(temperature_length);
param[14] = DXL_HIBYTE(temperature_length);

BulkData bd[256];
BulkData *pbd[256];
for(unsigned int i = 0 ; i <256 ; i++)
    pbd[i] = &bd[i];

dxl_bulk_read(Port, param, 15, pbd);

int present_current;
int present_position;
int present_temperature;

dxl_get_bulk_word( pbd, ID_1, P_PRESENT_CURRENT,
&present_current);
dxl_get_bulk_dword(pbd, ID_2, P_PRESENT_POSITION,
(unsigned*)&present_position);

```

```
    dxl_get_bulk_byte( pbd, ID_3, P_PRESENT_TEMPERATURE,
&present_temperature);
    present_current = (short int) present_current

    printf("Present Position\n");
    printf("ID_1 : %d\n", present_current);
    printf("ID_2 : %d\n", present_position);
    printf("ID_3 : %d\n", present_temperature);

    //Close the port of USB2DXL
    printf( "Press any key to terminate...\n" );
    _getch();
    dxl_terminate(Port);
    return 0;
}
```

1.3 Linux

1.3.1 Set-up

i. Checking USB-to-Dynamixel connection in Linux

- To the PC has detected the USB-to-Dynamixel device simply enter the command **ls /dev**
- Linux OS will display a list under the /dev directory simply look for “ttyUSB0”

```
root@robotis-linux:/home/robotis# ls /dev
alarm          mapper         sda1          tty29         tty6          ttyS31
ashmem         mcelog        sda2          tty3          tty60         ttyS4
ati           mem           sda5          tty30         tty61         ttyS5
autofs        net           serial        tty31         tty62         ttyS6
binder        network_latency sg0          tty32         tty63         ttyS7
block        network_throughput shm          tty33         tty7          ttyS8
bsg          null         snapshot     tty34         tty8          ttyS9
btrfs-control oldmem        snd          tty35         tty9          ttyUSB0
bus          port         stderr       tty36         ttyprintk    uinput
char         ppp          stdin        tty37         ttyS0        urandom
console      psaux        stdout       tty38         ttyS1        vcs
core        ptmx        tty          tty39         ttyS10       vcs1
```

ii. Verify proper serial device connection

- Note: there may be instances where the USB-to-Dynamixel dongle may show as “ttyUSB1” ”instead of the default “ttyUSB0.” This happens when another serial device has already been connected to the PC prior to connecting the USB-to-Dynamixel dongle.
- To get Linux to reassign ttyUSB0 to USB-to-Dynamixel disconnect all serial devices; then connect USB-to-Dynamixel loffowed by inputting the command **ls /dev**. The device should appear as ttyUSB0. Afterwards, you may connect other serial devices.

1.3.2 Download and install Dynamixel SDK 2.0

i. Preparing your system in Linux (assuming the PC is connected to the internet)

- Make sure to update your Linux OS package repositories with the command **apt-get update**.
- Dynamixel SDK 2.0 requires a C++ compiler (g++). To get it simply enter **apt-get install g++**.
- A text editor to read and change the code, if desired. Fortunately, Linux releases are accompanied by editors, such as Vim and G-edit.

ii. Obtain the source

- Visit support.robotis.com and go to the Dynamixel PRO section
- Download Linux version of the zipped SDK file

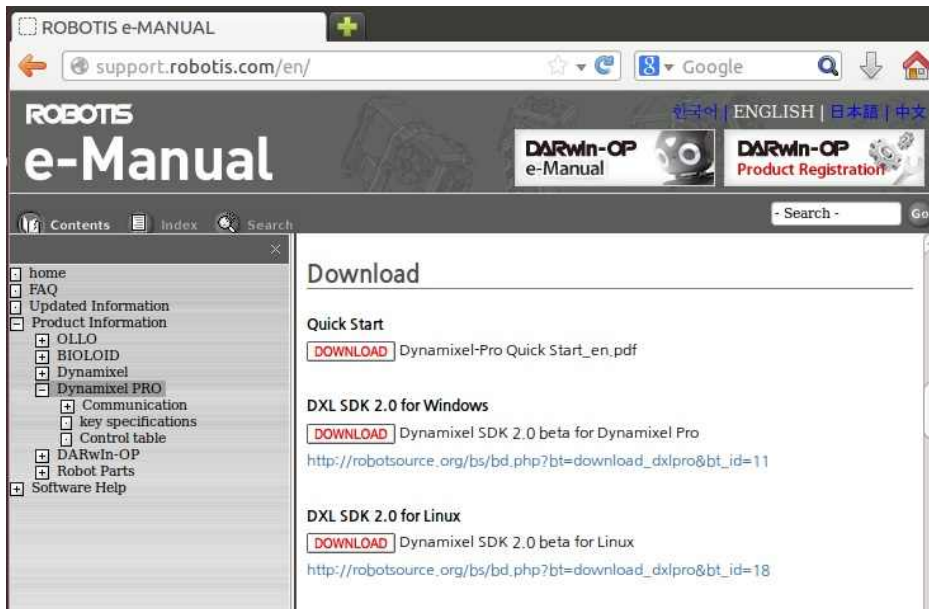

iii. Setup the source

- The current source is a beta release. The next steps will ensure proper setup of the beta release.
- [1] create a directory under root with the name `DXLSDK_cpp_forLinux` (`mkdir /DXLSDK_cpp_forLinux`);
- [2] move or copy the downloaded zip file to the new directory (`cp dxl sdk_cpp_forlinux.zip /DXLSDK_cpp_forLinux`);
- [3] go to the directory (`cd /DXLSDK_cpp_forLinux`);
- [4] unzip the file (`unzip dxl sdk_cpp_forlinux.zip`).

```

root@robotis-linux:/home/robotis/Downloads# ls
amd-driver-installer-catalyst-13-4-linux-x86.x86_64.zip
amd-driver-installer-catalyst-13-4-x86.x86_64.run
dxl sdk_cpp_forlinux.zip
root@robotis-linux:/home/robotis/Downloads# mkdir /DXLSDK_cpp_forLinux
root@robotis-linux:/home/robotis/Downloads# cp dxl sdk_cpp_forlinux.zip /DXLSDK_c
pp_forLinux/
root@robotis-linux:/home/robotis/Downloads# cd /DXLSDK_cpp_forLinux/
root@robotis-linux:/DXLSDK_cpp_forLinux# ls
dxl sdk_cpp_forlinux.zip
root@robotis-linux:/DXLSDK_cpp_forLinux# unzip dxl sdk_cpp_forlinux.zip
    
```

- After decompression verify the contents (type the command `ls`). Ignoring the zip file there should be the a few sub-directories (build, example, include, lib, and src) and `ReleaseNote.txt`.

```

root@robotis-linux:/DXLSDK_cpp_forLinux# ls
build dxl sdk_cpp_forlinux.zip example include lib ReleaseNote.txt src
root@robotis-linux:/DXLSDK_cpp_forLinux#
    
```

- Compile and build the source with the command `make && make install`. This will install and copy the source's library to the PC.

```

mkdir -p ../lib
g++ -O2 -O3 -DLINUX -D_GNU_SOURCE -Wall -c -I../include -fPIC -g -c ../src/bulkread.cpp -o ../build/bulkread.o
../src/bulkread.cpp: In member function 'bool Thor::BulkRead::ChangeBulkReadData(int, int, int)':
../src/bulkread.cpp:76:1: warning: control reaches end of non-void function [-Wreturn-type]
#ar cr /lib/libdxl.so ../build/serialport.o ../build/dynamixel.o ../build/bulkread.o
g++ -shared -fPIC -o ../lib/libdxl.so ../build/serialport.o ../build/dynamixel.o ../build/bulkread.o
mkdir -p ../build
mkdir -p ../lib
#ar cr /lib/libdxl.so ../build/serialport.o ../build/dynamixel.o ../build/bulkread.o
g++ -shared -fPIC -o ../lib/libdxl.so ../build/serialport.o ../build/dynamixel.o ../build/bulkread.o
cp "../lib/libdxl.so" "/usr/local/lib/libdxl.so"
ln -s "/usr/local/lib/libdxl.so" "/usr/local/lib/libdxl.so.2"
ln -s "/usr/local/lib/libdxl.so" "/usr/local/lib/libdxl.so.2.0"
ln -s "/usr/local/lib/libdxl.so" "/usr/local/lib/libdxl.so.2.0.0"
cp -r ../include/* /usr/local/include/

```

- Set-up is complete

1.3.3 Monitoring Dynamixel PRO

i. Monitor

- Linux is not currently supported by RoboPlus software. Fortunately, the downloaded SDK includes an utility called “monitor.” “Monitor is a simple command-line based tool that can perform every function of the Windows-based Dynamixel Wizard.
- To run monitor make sure you are in the example directory (/DXLSDK_cpp_forLinux/example). There will be 4 other sub-directories (each one is an example on implementation of Dynamixel SDK 2.0). Go to the monitor sub-directory (**cd monitor**).
- Browse the contents with the ls command and you will see 3 files (main.cpp, Makefile, and monitor* (*the file monitor, in white, is a remnant during the development of the SDK and it is not functional). Ignore monitor in white font since its not functional simple recompile the code again with the command **make**. After compilation browse the contents again and there should be monitor again, this time in green.

```

build dxlsdk_cpp_forlinux.zip example include lib ReleaseNote.txt src
root@robotis-linux:/DXLSDK_cpp_forLinux# cd example/
root@robotis-linux:/DXLSDK_cpp_forLinux/example# ls
BulkRead monitor ReadWrite SyncWrite
root@robotis-linux:/DXLSDK_cpp_forLinux/example# cd monitor
root@robotis-linux:/DXLSDK_cpp_forLinux/example/monitor# ls
main.cpp Makefile monitor
root@robotis-linux:/DXLSDK_cpp_forLinux/example/monitor# make
mkdir -p .objects/
g++ -O2 -O3 -DLINUX -D_GNU_SOURCE -Wall -I/DXLSDK_cpp_forLinux/include -g .objects/main.o -ldxl -o monitor
root@robotis-linux:/DXLSDK_cpp_forLinux/example/monitor# ls
main.cpp Makefile monitor
root@robotis-linux:/DXLSDK_cpp_forLinux/example/monitor#

```

To run monitor simply enter the command **./monitor**.

1.3.4 Functions of monitor

i. Scanning for Dynamixel PRO(s)

- For information on how to operate “monitor” simply enter the command help.”Monitor” outputs a list of available commands.

```

COMMAND:
baud [BAUD_NUM]          : Baudrate change to [BAUD_NUM]
                          0:2400, 1:57600, 2:115200, 3:1M, 4:2M, 5:3M
                          6:4M, 7:4.5M, 8:10.5M
scan                     : Output the current status of all DXLs
ping [ID] [ID] ...      : Output the current status of [ID]
bp                       : Broadcast Ping
wrb|w [ID] [ADDR] [VALUE] : Write 1 byte [VALUE] to [ADDR] of [ID]
wrw [ID] [ADDR] [VALUE]  : Write 2 byte [VALUE] to [ADDR] of [ID]
 wrd [ID] [ADDR] [VALUE]  : Write 4 byte [VALUE] to [ADDR] of [ID]
rdb [ID] [ADDR]          : Read 1 byte value from [ADDR] of [ID]
rdw [ID] [ADDR]          : Read 2 byte value from [ADDR] of [ID]
rdd [ID] [ADDR]          : Read 4 byte value from [ADDR] of [ID]
 r [ID] [ADDR] [LENGTH]  : Dumps the control table of [ID]
                          [LENGTH] bytes from [ADDR]
mon [ID] [ADDR] b|w|d    : Refresh byte|word|dword from [ADDR] of [ID]
reboot [ID]              : Reboot the dynamixel of [ID]
reset [ID] [OPTION]      : Factory reset the dynamixel of [ID]
                          OPTION: 255(All), 1(Except ID), 2(Except ID&Baud)
exit                     : Exit this program

[CMD]
    
```

- Notice there 3 types of read and 3 type of write commands. This is because addresses come in 3 different sizes; a byte, a word (2 bytes), or a double-word “dword” (4 bytes/2 words).
- For bytes apply **rdb** for read and **wrb** for write
- For word apply **rdw** for read and **wrw** for write
- For dword apply **rdd** for read and **wrd** for write.
- Inputting the wrong read or write command for the address will result in a failed or erroneous read or write command
- To scan for Dynamixel PRO(s) simply enter the command **scan**. Another alternative command to check connected Dynamixel PRO(s) is **bp**.

```

[CMD] scan

[ID:001] Model No : 53768 (0x08 0xD2) ... SUCCESS
.....
.....
.....
[CMD] █
    
```

- You will see “[ID:001] ...” This means that the connected Dynamixel PRO is assigned ID 1 (factory default).
- Note: when connecting multiple Dynamixel PROs to the Pc do so one at a time. This is because every new Dynamixel PRO ships with factory default ID of 1; otherwise. When multiple Dynamixel PROs are connected simultaneously “monitor” will not be able to perform a proper scan and it will output as if no Dynamixel PROs are connected (Change of ID number is explained further in this documentation).

ii. Setting the baud rate of USB-to-Dynamixel dongle

- This step is very important as the communications speed between USB-to-Dynamixel and Dynamixel PRO(s) must be synchronized. Failing to have a synched baud rate may result in Monitor failing to scan, read, and sent write commands to Dynamixel PRO(s).

- By default this utility sets USB-to-Dynamixel baud rate to 1 (57600 bps). Changes in baud rate for the USB-to-Dynamixel dongle and Dynamixel PRO will be explained further in this guide.

iii. Enabling Torque

- By default Torque Enable (address #562) is disabled. According to Dynamixel PRO's control table the size of address 562 is of 1 byte. This means that the proper command to obtain a readout for address 562 should be **rdb 1 562**

```
[CMD] rdb 1 562  
  
READ VALUE : 0  
  
[CMD]
```

- The read value should output 0 (off), and indeed, "monitor" confirms Torque Enable being off.
- To turn Torque Enable on enter the command **wrb 1 562 1**. (Don't forget to be able to change address values from the EEPROM area ensure that address 562 is set to off).

```
[CMD] wrb 1 562 1  
  
Success to write!  
  
[CMD] rdb 1 562  
  
READ VALUE : 1  
  
[CMD]
```

Dynamixel PRO is now ready to operate

iv. Goal Position

- According to Dynamixel PRO's Control Table Goal Position is located on address 596 with a size of 4 bytes (a double-word or "dword").
- To set a Goal Position to the 9-o'clock position the command should be **wrd 1 596 125500** (for 54-series) or **wrd 596 75937** (for 42-series)
- Dynamixel rotates 90 degree.

```
[CMD] wrd 1 596 125500  
  
Success to write!  
  
[CMD]
```

v. Present Position

- According to Dynamixel PRO's Control Table Present Position is located on address 611 with a size of 4 bytes (a double-word or "dword").
- To read Present Position the command is **rdd 1 611**

```
[CMD] rdd 1 611  
  
READ VALUE : (UNSIGNED) 125498 , (SIGNED) 125498  
  
[CMD] █
```

- “Monitor” will output 2 values, unsigned and signed values. Position values greater or equal than 0 will have the same unsigned and signed values. However, values lesser than 0 will have 2 different values (with the unsigned value never being a negative value). This is due to the - sign is assigned a 1 at the most-significant-bit digit of Present Position. In this case ignore the unsigned value.
- *Proof: When present position returns a position lesser than 0 the unsigned value always start with a 4e9 value. A value with a magnitude is 4e10 is only possible when is binary equivalent is at least 32-bit long integer. Present Position is 4 bytes in size or 32 bits.*

```
[CMD] wrd 1 596 -125500  
  
Success to write!  
  
[CMD] rdd 1 611  
  
READ VALUE : (UNSIGNED) 4294841794 , (SIGNED) -125502  
  
[CMD] █
```

vi. Min/Max Positions

- According to Dynamixel PRO’s Control Table Max Position is located on address 36 with a size of 4 bytes (a double-word or “dword”) and Min Position is located on address 40 with 4 bytes as well.
- Both addresses are in the EEPROM area so Torque Enable must be off. By default the Min and Max positions are set to max (or min) to allow full range of motion.

```
[CMD] rdd 1 36  
  
READ VALUE : (UNSIGNED) 251000 , (SIGNED) 251000  
  
[CMD] rdd 1 40  
  
READ VALUE : (UNSIGNED) 4294716296 , (SIGNED) -251000  
  
[CMD] █
```

- Set a sample min or max value (**wrd 1 36 9000**); then set a Goal Position with the allowed range followed by setting a Goal Position outside range. When setting a Goal Position outside range the result is a failure to write.

```
[CMD] wrd 1 596 8800
Success to write!
[CMD] wrd 1 596 200000
Fail to write!
[CMD] wrd 1 596 20000
Fail to write!
[CMD] █
```

In this example the value in blue denotes a Goal Position within the max range of 9000 while the values in red are outside 9000.

vii. Goal Torque

- According to Dynamixel PRO's Control Table Goal Torque is located on address 604 with a size of 2 bytes (a word).
- Keep in mind that by default the Operating Mode (address 11 of size 1 byte) is set to 3 (Joint Mode) therefore Operating Mode must be set to 0 (Toque Mode). Operating Mode is in the EEPROM area so Torque Enable must of turned off before making any changes.
- Before testing Goal Torque make sure to check Torque Limit (address 30, 2 bytes) as Goal Troque cannot exceed Torque Limit. Remember: Torque Limit is also in the EEPROM area so Torque Enable must be turned off to make any changes.
- Obtain a reading of Torque Limit (**rdw 1 30**) then set Goal Torque within the limit and outside the limit.

```
[CMD] rdw 1 30
READ VALUE : (UNSIGNED) 310 , (SIGNED) 310
[CMD] wrw 1 604 100
Success to write!
[CMD] wrw 1 604 400
ErrorCode : 2 (0x2)
Angle limit error!
Success to write!
[CMD] █
```

In this example Torque Limit outputs a value of 310. Blue denotes a successful write with a Goal Torque of 100 (less than 310), and red denotes a Goal Torque outside the limit

viii. Goal Velocity

- According to Dynamixel PRO's Control Table Goal Velocity is located on address 600 with a size of 4 bytes (a dword).
- Keep in mind that Operating Mode must be set to 1 (Wheel Mode). Operating Mode is in the EEPROM area so Torque Enable must be turned off before making any changes.
- Before testing Goal Velocity make sure to check Velocity Limit (address 32, 2 bytes) as Goal Velocity cannot exceed velocity Limit. Remember: Torque Limit is also in the EEPROM area so Torque Enable must be turned off to make any changes
- Try rotating Dynamixel PRO counterclockwise (CCW direction) by setting values above 0, i.e. **wrd 1 600 200**. Try the same in the clockwise direction (CW direction) by setting values below 0, i.e. **wrd 1 600 -200**.
- To stop Dynamixel PRO simply enter a velocity value of 0 (enter the command **wrd 1 600 0**) or turn Toruq Enable off (enter the command **wrb 1 562 0**).

ix. Changing ID

- According to Dynamixel PRO's Control Table ID is located on address 7 with a size of 1 byte. ID is located under the EEPROM area so Torque Enable (#562) must be turned off before making any changes.
- The following procedure is the simple way to change ID of Dynamixel PRO (assuming default ID of 1: [1] ensure Torque Enable is off (value = 0) by the command **rdb 1 562**, [2] enter the command to change ID number to, i.e. #39), with the command **wrb 1 7 39**, [3] to verify scan for Dynamixel with **scan**.

```
[CMD] scan

[ID:001] Model No : 53768 (0x08 0xD2) ... SUCCESS
.....
.....
.....

[CMD] rdb 1 562

READ VALUE : 0

[CMD] wrb 1 7 39

Success to write!

[CMD] scan

.....
.....
.....
.....

[ID:039] Model No : 53768 (0x08 0xD2) ... SUCCESS
.....
.....
.....

[CMD] █
```

This example illustrates a procedure to properly change of ID of a Dynamixel PRO from 1 to 39

- With Dynamixel PRO assigned an ID number different than 1 it is now possible to daisy-chain another Dynamixel PRO.
- x. Baud rate
- As stated previously the default setting for baud rate of USB-to-Dynamixel is 1 (57600 bps). The factory default setting for Dynamixel PRO is also 1.
 - According to Dynamixel PRO's Control Table ID is located on address 8 with a size of 1 byte. ID is located under the EEPROM area so Torque Enable (#562) must be turned off before making any changes.
 - Assuming that Torque Enable is set to off let's change the baud rate of Dynamixel PRO to 1 Mbps (value = 3). In this case since the ID has been changed from 1 to 39 the proper command should be **wrb 39 8 3**.
 - Perform a scan with scan (do it twice, three times, etc) and notice that Monitor will be able to scan for ID 39. The reason is because the baud rate of ID 39 and USB-to-Dynamixel don't match.

```
[CMD] scan
.....
[ID:039] Model No : 53768 (0x08 0xD2) ... SUCCESS
.....

[CMD] wrb 39 8 3

Success to write!

[CMD] scan
.....
.....
.....
.....
.....

[CMD]
```

In this example the first scan (highlighted in blue) is successful because both USB-to-Dynamixel and Dynamixel PRO have the same baud rate of 57600 bps. After changing baud rate to 1 Mbps to Dynamixel PRO scan fails (highlighted in red).

- To set the baud rate of USB-to-Dynamixel simply enter the command **baud 3**. Afterwards perform a scan and ID 39 will reappear again.

```
[CMD] baud 3
Success to change baudrate! [ BAUD NUM: 3 ]
[CMD] scan
.....
.....
.....
.....
.....

[CMD]
```

After changing the baud rate of USB-to-Dynamixel to match ID 39 the scan is successful

- If there are other Dynamixel PROs connected in daisy-chain make sure to also change the baud rate of these Dynamixel PROs too before changing the baud rate of USB-to-Dynamixel. When performing this procedure the Dynamixel PROs may remain daisy chained.
- xi. Resetting Dynamixel PRO to factory-default settings.
- Monitor allows for resetting any Dynamixel PRO to factory-default settings. Before exercising this option it is strongly recommended that only one Dynamixel PRO is connected (remove any other daisy-chained Dynamixel PROs).
 - For example the current Dyanmixel PRO in use is currently set with ID 39 and a baud rate of 3 (1 Mbps). The following are the available options
 - The command **reset 39 255** resets all settings
 - The command **reset 39 1** resets all settings except ID number
 - The command **reset 39 2** resets all settings except ID number and baud rate

```
[CMD] bp
cnt: 14, Interval: 114.924990 / Wait time: 793.280000

[ID:039] Model No : 53768 (0x08 0xD2) ... SUCCESS

[CMD] reset 39 1

Success to reset!

[CMD] baud 1
Success to change baudrate! [ BAUD NUM: 1 ]
[CMD] bp
cnt: 4, Interval: 116.717084 / Wait time: 1370.500000
cnt: 6, Interval: 117.711084 / Wait time: 1370.500000
cnt: 4, Interval: 118.713084 / Wait time: 1370.500000

[ID:039] Model No : 53768 (0x08 0xD2) ... SUCCESS

[CMD] █
```

The illustration above shows a Dynamixel PRO (blue line) with ID 39 and a baud rate of 1 Mbps (not shown) via alternative scan command bp. Then, this Dynamixel PRO is set to factory reset except for the ID number (reset 39 1). The USB-to-Dynamixel is baud rate is set to match the factory –default baudrate of Dynamixel PRO (command baud 1). Factory –default reset (except ID number) is confirmed by a following scan with the bp command highlighted in red.

1.4 Examples (Linux)

1.4.1 This section assumes the following:

- 1) USB-to-Dynamixel dongle is registered under `tttyUSB0`
- 2) Dynamixel PRO device is in factory-default settings
- 3) SDK 2.0 is properly set-up
- 4) Torque Enable (562) is set to 0 (off state)

1.4.2 Initializing USB-to-Dynamixel and Dynamixel PRO

- i. Connect (`/sdk_20_directory/example/Connect/main.cpp`)
 - USB-to-Dynamixel is registered under `tttyUSB0` in `/dev`
 - To initialize (open port) simply enter its location at the course code.
 - Before ending the program USB-to-Dynamixel must be disconnected (close port)

```
/dxl_sdk-20/example/Connect/main.cpp (partly shown)
...
using namespace DXL_PRO;

int main()
{
    Dynamixel DXL("/dev/ttyUSB0"); // must declare location of USB-to-Dynamixel

    // open device
    if( DXL.Connect() == 0 )
    {
        printf( "Failed to open USB2Dynamixel!\n" );
        return 0;
    }
    else
```

```

printf( "Succeed to open USB2Dynamixel!\n" );

// must close USB-to-Dynamixel before ending
DXL.Disconnect();
return 0;
}

```

ii. Enabling Dynamixel PRO

- As previously mentioned baud rate of Dynamixel PRO and USB-to-Dynamixel must match.
- This can be easily achieved by simply setting the value for baud rate.
- After setting matching baud rate write commands to EEPROM area can be sent
- Torque Enable must be on to send write commands to the RAM area.
- Read commands can be sent at any time regardless of Torque Enable value.

/dxl_sdk-20/example/TorqueEnable/main.cpp (partly shown)

```

// declare the following in preprocessor for illustrative purposes

#define TORQUE_ENABLE      562
#define DEFAULT_BAUDNUM   1
...
using namespace DXL_PRO;

Dynamixel DXL("/dev/ttyUSB0"); // must declare location of USB-to-Dynamixel

int main()
{
    int result, error = 0, On; // declare arbitrary variables for read commands
    // open device
    if( DXL.Connect() == 0 )
    {
        printf( "Failed to open USB2Dynamixel!\n" );
        return 0;
    }
    else
        printf( "Succeed to open USB2Dynamixel!\n" );
    // Now verify baudrate USB-to-Dynamixel
    if(DXL.SetBaudrate(DEFAULT_BAUDNUM) == true)
    {
        printf( "Succeed to set USB2DXL baudrate to 57600 bps!\n" );
    }
    else
    {
        printf( "Failed to set USB2DXL baudrate to 57600 bps!\n" );
        printf( "Press any key to end ...\n" );
        _getch();
        return 0;
    }
    printf( "Turning Torque Enable on for ID 1\n" );
}

```



```

// This step is essential. After Torque Enable is on RAM area addresses can be changed.
DXL.WriteByte(1, TORQUE_ENABLE, 1, 0);

// after enabling Torque Enable
// sad main routine involving RAM address(es) here (i.e. Goal Position)
...
// the following lines verify that Dynamixel's Torque Enable has been turned on
// by outputting a "1" onscreen
result = DXL.ReadByte(1, TORQUE_ENABLE, &On, &error);
if(result == COMM_RXSUCCESS)
    printf( "%d\n", On);

// must close USB-to-Dynamixel before ending
DXL.Disconnect();
return 0;
}

```

1.4.3 Implementing read/write functions

i. Write functions

- Monitor for Dynamixel PRO in Linux emphasized that different size addresses required different type of write commands. The same concept applies at the source code level.
- There are 4 types of write commands for Dynamixel PRO
- Implement `WriteByte` for addresses with size of 1 byte
- Implement `WriteWord` for addresses with size of 2 bytes
- Implement `WriteDWord` for addresses with size of 4 bytes
- Implement `SyncWrite` (explained later) for for multiple Dynamixel PROs at once.

ii. Read functions

- Monitor for Dynamixel PRO in Linux emphasized that different size addresses required different type of read commands. The same concept applies at the source code level.
- There are 4 types of write commands for Dynamixel PRO
- Implement `ReadByte` for addresses with size of 1 byte
- Implement `ReadWord` for addresses with size of 2 bytes
- Implement `ReadDWord` for addresses with size of 4 bytes
- Implement `BulkRead` (explained later) for multiple Dynamixel PROs at once.

The following example is a simple read/write sample code of Dynamixel PRO in Joint Mode (default)

```

/dxl_sdk-20/example/ReadWrite/main.cpp (partly shown)
// declare the following in preprocessor for illustrative purposes

#define P_TORQUE_ENABLE          562
#define P_GOAL_POSITION_LL      596
#define P_PRESENT_POSITION_LL   611
#define P_MOVING                 610

```

```

#define DEFAULT_BAUDNUM      1
#define DEFAULT_ID          1
...
using namespace DXL_PRO;

Dynamixel DXL("/dev/ttyUSB0"); // must declare location of USB-to-Dynamixel

int main()
{
    int result, error = 0, index = 0, PresentPos = 0, On; // declare arbitrary variables for read
    commands
    int GoalPos[2] = (-150000, 150000);
    ...
    // open device
    if( DXL.Connect() == 0 )
    {
        printf( "Failed to open USB2Dynamixel!\n" );
        return 0;
    }
    else
        printf( "Succeed to open USB2Dynamixel!\n" );
    // Now verify baudrate USB-to-Dynamixel
    if(DXL.SetBaudrate(DEFAULT_BAUDNUM) == true)
    {
        printf( "Succeed to set USB2DXL baudrate to 57600 bps!\n" );
    }
    else
    {
        printf( "Failed to set USB2DXL baudrate to 57600 bps!\n" );
        printf( "Press any key to end ...!\n" );
        _getch();
        return 0;
    }
    printf( "Turning Torque Enable on for ID 1\n" );
    // This step is essential. After Torque Enable is on RAM area addresses can be changed.
    DXL.WriteByte(DEFAULT_ID, P_TORQUE_ENABLE, 1, &error);
    ...
    While(1);
    ...
    DXL.WriteDWord(DEFAULT_ID, P_GOAL_POSITION_LL, GoalPos[index], &error);
    do {
    ...
    result = DXL.ReadDWord(DEFAULT_ID, P_PRESENT_POSITION_LL, &PresentPos,
&error);
    if (result == COMM_RXSUCCESS)
        printf( " %d %d\n", GoalPos[index], PresentPos);
    ...
    // must close USB-to-Dynamixel before ending
    DXL.Disconnect();
    return 0;
}

```

}

Similarly several types of write commands can be implemented according to the size of the corresponding address.

The following example combines several features of Dyanmixel PRO, such as Operating Mode (11) and its different type of operations; and implementing their respective write function.

This example also illustrates how the user can easily turn Torque Enable on and off at will enabling easy manipulation of EEPROM addresses.

/dxl_sdk-20/example/OperatingMode/main.cpp (partly shown)

```

...
// declare the following in preprocessor for illustrative purposes
#define OPERATING_MODE      11
#define TORQUE_ENABLE      562
#define GOAL_POSITION      596
#define GOAL_TORQUE        604
#define GOAL_VELOCITY      600
#define DEFAULT_BAUDNUM    1
#define CONTROL_PERIOD     (10) // time period, arbitrary value
...
using namespace DXL_PRO;

Dynamixel DXL("/dev/ttyUSB0"); // must declare location of USB-to-Dynamixel

int main()
{
    int GoalPos 250000; // for 54-series
    // int GoalPos = 151875; // for 42-series
    int GoalVel = -30001
    int GoalTorque = 120;
    ...
    // open device and set baud rate here
    if( DXL.Connect() == 0 )
    ...
    // Torque Enable is off by default
    // The following line is not necessary but it ensures
    // Torque Enable is off regardless
    DXL.WriteByte(1, TORQUE_ENABLE, 0, 0);
    ...
    While(1); {
        switch(_getch()) { // use simply switch loop to change between modes
            case 0x1b: // ESC key to set to default settings
                DXL.WriteByte(1, TORQUE_ENABLE, 0, 0);
                usleep(CONTROL_PERIOD*100);
                DXL.WriteByte(1, OPERATING_MODE, 3, 0);
                break;
            case 0x30: // "0" key to set in Torque Mode
                DXL.WriteByte(1, OPERATING_MODE, 0, 0);
                usleep(CONTROL_PERIOD*100);
                DXL.WriteByte(1, TORQUE_ENABLE, 1, 0);
                usleep(CONTROL_PERIOD*100);
                // Goal Torque (604) size is 2 bytes (a word)/

```

```

        // WriteWord is the appropriate function
        DXL.WriteWord(1, GOAL_TORQUE, GoalTorque, 0);
        break;
    case 0x31: // "1" key to set in Wheel Mode
        DXL.WriteByte(1, OPERATING_MODE, 1, 0);
        usleep(CONTROL_PERIOD*100);
        DXL.WriteByte(1, TORQUE_ENABLE, 1, 0);
        usleep(CONTROL_PERIOD*100);
        // Goal Velocity (600) size is 4 bytes (a double-word)
        // WriteDWord is the appropriate function
        DXL.WriteDWord(1, GOAL_VELOCITY, GoalVel, 0);
        break;
    default: // every other key and Dynamixel PRO remains in Joint Mode
        DXL.WriteByte(1, OPERATING_MODE, 3, 0);
        usleep(CONTROL_PERIOD*100);
        DXL.WriteByte(1, TORQUE_ENABLE, 1, 0);
        usleep(CONTROL_PERIOD*100);
        // Goal Position (596) size is 4 bytes (a double-word)
        // WriteDWord is the appropriate function
        DXL.WriteDWord(1, GOAL_POSITION, GoalPos, 0);
        break; }
}

...
// must close USB-to-Dynamixel before ending
DXL.Disconnect();
return 0;
}

```

Similarly as multiple write functions can be applied; multiple read functions can be implemented.

/dxl_sdk-20/example/ReadValues/main.cpp (partly shown)

```

...
// declare the following in preprocessor for illustrative purposes
#define OPERATING_MODE      11
#define TORQUE_ENABLE       562
#define GOAL_POSITION       596
#define GOAL_TORQUE         604
#define GOAL_VELOCITY       600
#define PRESENT_POSITION    611
#define PRESENT_CURRENT     621
#define PRESENT_VELOCITY    615
#define DEFAULT_BAUDNUM     1
#define CONTROL_PERIOD      (10) // time period, arbitrary value
...
using namespace DXL_PRO;

Dynamixel DXL("/dev/ttyUSB0"); // must declare location of USB-to-Dynamixel

int main()
{
    int GoalPos 250000; // for 54-series
}

```

```

// int GoalPos = 151875; // for 42-series
int GoalVel = -30001
int GoalTorque = 120;
int result = COMM_TXFAIL;
int error = 0;
int val1, val2, val3;
...
// open device and set baud rate here
if( DXL.Connect() == 0 )
...
// Torque Enable is off by default
// The following line is not necessary but it ensures
// Torque Enable is off regardless
DXL.WriteByte(1, TORQUE_ENABLE, 0, 0);
...
While(1); {
    switch(_getch()) { // use simply switch loop to change between modes
        case 0x1b: // ESC key to set to default settings
            DXL.WriteByte(1, TORQUE_ENABLE, 0, 0);
            usleep(CONTROL_PERIOD*100);
            DXL.WriteByte(1, OPERATING_MODE, 3, 0);
            break; }
        case 0x30: // "0" key to set in Torque Mode
            DXL.WriteByte(1, OPERATING_MODE, 0, 0);
            usleep(CONTROL_PERIOD*100);
            DXL.WriteByte(1, TORQUE_ENABLE, 1, 0);
            usleep(CONTROL_PERIOD*100);
            // Goal Torque (604) size is 2 bytes (a word)/
            // WriteWord is the appropriate function
            DXL.WriteWord(1, GOAL_TORQUE, GoalTorque, &error);
            usleep(CONTROL_PERIOD*200);
            // after an arbitrary period (i.e. 2 secs in this case)
            // output onscreen
            // Present Current (621) size is 2 bytes (a word)
            // ReadWord is the appropriate function
            result = DXL.ReadWord(1, PRESENT_CURRENT, &val1, &error);
            if(result == COMM_RXSUCCESS)
                printf( "%d\n", val1);
            break; }
        case 0x31: // "1" key to set in Wheel Mode
            DXL.WriteByte(1, OPERATING_MODE, 1, 0);
            usleep(CONTROL_PERIOD*100);
            DXL.WriteByte(1, TORQUE_ENABLE, 1, 0);
            usleep(CONTROL_PERIOD*100);
            // Goal Velocity (600) size is 4 bytes (a double-word)
            // WriteDWord is the appropriate function
            DXL.WriteDWord(1, GOAL_VELOCITY, GoalVel, &error);
            usleep(CONTROL_PERIOD*200);
            // after an arbitrary period (i.e. 2 secs in this case)
            // output onscreen

```

```

// Present Velocity (615) size is 4 bytes (a double-word)
// ReadDWord is the appropriate function
result = DXL.ReadDWord(1, PRESENT_VELOCITY, &val2, &error);
if(result == COMM_RXSUCCESS)
    printf( "%d\n", val2);
break; }

default: // every other key and Dynamixel PRO remains in Joint Mode
DXL.WriteByte(1, OPERATING_MODE, 3, 0);
usleep(CONTROL_PERIOD*100);
DXL.WriteByte(1, TORQUE_ENABLE, 1, 0);
usleep(CONTROL_PERIOD*100);
// Goal Position (596) size is 4 bytes (a double-word)
// WriteDWord is the appropriate function
DXL.WriteDWord(1, GOAL_POSITION, GoalPos, &error);
usleep(CONTROL_PERIOD*200);
// after an arbitrary period (i.e. 2 secs in this case)
// output onscreen
// Present Position (611) size is 4 bytes (a double-word)
// ReadDWord is the appropriate function
result = DXL.ReadDWord(1, PRESENT_POSITION, &val3, &error);
if(result == COMM_RXSUCCESS)
    printf( "%d\n", val3);
break; }

}

...
// must close USB-to-Dynamixel before ending
DXL.Disconnect();
return 0;
}

```

iii. SyncWrite

- While the abovementioned read and write commands are simple to implement the amount of code lines necessary for multiple addresses on multiple Dynamixel PROs can be rather staggering.
- SyncWrite simplifies commands by setting, preparing and then transmitting data packets.
- SyncWrite allows one single commands to address multiple values for multiple Dynamixel PROs at a given address.

The following example illustrates a single SyncWrite command to set different Goal Positions to more than 1 Dynamixel PRO

/dxl_sdk-20/example/SyncWrite/main.cpp (partly shown)

```

...
// declare the following in preprocessor for illustrative purposes
#define OPERATING_MODE      11
#define TORQUE_ENABLE       562
#define GOAL_POSITION       596
#define GOAL_TORQUE         604

```

```

...
using namespace DXL_PRO;

Dynamixel DXL("/dev/ttyUSB0"); // must declare location of USB-to-Dynamixel

int main()
{
    int GoalPos, i;
    int id[NUM_ACTUATOR];
    int phase[NUM_ACTUATOR];
    ...
    // open device and set baud rate here
    if( DXL.Connect() == 0 )
    ...
    DXL.WriteByte(1, TORQUE_ENABLE, 1, 0); // for ID 1
    // do the same for other IDs
    ...
    do {
        for (i= 0; i < NUM_ACTUATOR; i++) {
            GoalPos = (int)((sin(theta+phase[i]))(double)AmPos);
            // packet preparation set below.
            // ID requires 1 byte
            // Goal Position requires 4 bytes
            // in this case different Goal Position values for different ID
            param[i*(1+4)+0] = (unsigned char)id[i];
            param[i*(1+4)+1] = DXL_LOBYTE(DXL_LOWORD(GoalPos));
            param[i*(1+4)+2] = DXL_HIBYTE(DXL_LOWORD(GoalPos));
            param[i*(1+4)+3] = DXL_LOBYTE(DXL_HIWORD(GoalPos));
            param[i*(1+4)+4] = DXL_HIBYTE(DXL_HIWORD(GoalPos));
        }
        // 4 is for size of Goal Position, NUM_ACTUATOR is for size of array
        result = DXL.SyncWrite(P_GOAL_POSITION_LL, 4, param, NUM_ACTUATOR*(1+4));
        ...
        while (theta < 2*PI);
        // must close USB-to-Dynamixel before ending
        DXL.Disconnect();
        return 0;
    }
}

```

iv. BulkRead

- Like SyncWrite BulkRead allows reading multiple addresses of multiple Dynamixel PROs simultaneously

/dxl_sdk-20/example/BulkRead/main.cpp (partly shown)

```

...
using namespace DXL_PRO;

Dynamixel DXL("/dev/ttyUSB0"); // must declare location of USB-to-Dynamixel

int main()

```

```

{
...
int id[NUM_ACTUATOR];
int phase[NUM_ACTUATOR];
...
// open device and set baud rate here
if( DXL.Connect() == 0 )
...
DXL.WriteByte(1, TORQUE_ENABLE, 1, 0); // for ID 1
// do the same for other IDs
...
while(1) {
...
    result = bulkread.SendTxPacket();
    ...
    for (i = 0; i < NUM_ACTUATOR; i++) (
        bulkread.GetDWordValue(id[i], addr[i] (long*)&read_val);
        printf("ID : %d,  READ_VALUE : %d\n", id[i], read_val);
        // print out address(es) values of IDs invollved
    )
}
...
// must close USB-to-Dynamixel before ending
DXL.Disconnect();
return 0;
}

```

v. WriteByte/WriteWord/WriteDWord vs SyncWrite

- Although both are write commands their implementation can be quite different.
- WriteByte WriteWord, WriteDWord are explicit write commands that allow writing specific IDs at specific addresses (i.e. LED control on ID 1 while ID 2 rotates in wheel mode). The user has much greater control of Dynamixel PRO with these commands. The drawback on implementing this fuction is that with multiple IDs with multiple addresses then the code can become very long.
- SyncWrite, in the other hand, is a more implicit write command. One command is enough for multiple IDs. The drawback is that the user does not have as much control as with WriteByte/Word/DWord since SynchWrite does not allow control of specific addresses from specific IDs at a given moment.
- Notice the difference from the sample codes from OperatingMode and SyncWrite. OperatingMode require many write commands for different Control Table addresses, while SynchWrite is much shorter but only deals with one Control Table address

2 Reference

2.1 Default values by model

2.1.1 H Series

i. H54-200-S500-R

Name	Default Value
ID	1
BaudRate	1 (57600bps)
Max Position Limit	251000
Min Position Limit	-251000
Velocity Limit	16600
Current Limit	620
Velocity I Gain	14
Velocity P Gain	399
Position P Gain	32

ii. H54-100-S500-R

Name	Default Value
ID	1
BaudRate	1 (57600bps)
Max Position Limit	251000
Min Position Limit	-251000
Velocity Limit	17000
Current Limit	310
Velocity I Gain	16
Velocity P Gain	256
Position P Gain	32

iii. H42-20-S300-R

Name	Default Value
ID	1
BaudRate	1 (57600bps)
Max Position Limit	151875
Min Position Limit	-151875
Velocity Limit	10300
Current Limit	465
Velocity I Gain	40
Velocity P Gain	440
Position P Gain	32

2.1.2 M Series

i. M54-60-S250-R

Name	Default Value
ID	1
BaudRate	1 (57600bps)

Max Position Limit	125700
Min Position Limit	-125700
Velocity Limit	8000
Current Limit	180
Velocity I Gain	16
Velocity P Gain	256
Position P Gain	32

ii. M54-40-S250-R

Name	Default Value
ID	1
BaudRate	1 (57600bps)
Max Position Limit	125700
Min Position Limit	-125700
Velocity Limit	8000
Current Limit	180
Velocity I Gain	16
Velocity P Gain	256
Position P Gain	32

2.1.3 L Series

i. L54-50-S290-R

Name	Default Value
ID	1
BaudRate	1 (57600bps)
Max Position Limit	103860
Min Position Limit	-103860
Velocity Limit	8000
Current Limit	180
Velocity I Gain	16
Velocity P Gain	256
Position P Gain	32

ii. L54-30-S400-R

Name	Default Value
ID	1
BaudRate	1 (57600bps)
Max Position Limit	144180
Min Position Limit	-144180
Velocity Limit	13000
Current Limit	180
Velocity I Gain	16
Velocity P Gain	256
Position P Gain	32

iii. L42-10-S300-R

Name	Default Value
ID	1
BaudRate	1 (57600bps)
Max Position Limit	151875
Min Position Limit	-151875
Velocity Limit	
Current Limit	
Velocity I Gain	
Velocity P Gain	
Position P Gain	

2.2 Control Table of Dynamixel Pro

(R : Read, RW : Read and Write)

AREA	address	size (byte)	feature	description	type	Default value
EEPROM	0	2	Model Number	Model number	R	-
	6	1	Version of Firmware	Firmware version info	R	-
	7	1	ID	ID of Dynamixel PRO	RW	1
	8	1	Baud Rate	Baud rate	RW	1
	9	1	Return Delay Time	Return delay time	RW	250
	11	1	Operating mode	Operating mode	RW	3
	13	4	Homing offset	Homing value	RW	0
	17	4	Moving threshold	Moving threshold	RW	50
	21	1	Temperature limit	Internal temperature limit	RW	80
	22	2	Max Voltage Limit	Operating upper limit voltage	RW	400
	24	2	Min Voltage Limit	Operating lower limit voltage	RW	150
	26	4	acceleration Limit	Acceleration limit	RW	-
	30	2	Torque limit	Torque limit	RW	-
	32	4	Velocity Limit	Velocity limit	RW	-
	36	4	Max Position Limit	Position upper limit	RW	-
	40	4	Min Position Limit	Position lower limit	RW	-
	44	1	External Port Mode 1	External Port Mode 1	RW	0
	45	1	External Port Mode 2	External Port Mode 2	RW	0
	46	1	External Port Mode 3	External Port Mode 3	RW	0
	47	1	External Port Mode 4	External Port Mode 4	RW	0
	48	1	Shutdown	Shutdown	RW	26
	49	2	Indirect Address 1	Indirect Address 1	RW	634
	51	2	Indirect Address 2	Indirect Address 2	RW	635
	53	2	Indirect Address 3	Indirect Address 3	RW	636
	Indirect Address N	RW	-
569	2	Indirect Address 256	Indirect Address 256	RW	889	

RAM	562	1	Torque Enable	torque On/Off	RW	0
	563	1	LED RED	RED LED intensity value	RW	0
	564	1	LED GREEN	GREEN LED intensity value	RW	0
	565	1	LED BLUE	BLUE LED intensity value	RW	0
	586	2	Velocity I Gain	Velocity I Gain	RW	-
	588	2	Velocity P Gain	Velocity P Gain	RW	-
	594	2	Position P Gain	Velocity P Gain	RW	-
	596	4	Goal position	Target position value	RW	-
	600	4	Goal velocity	Target velocity value	RW	0
	604	2	Goal Torque	Target torque value	RW	0
	606	4	Goal acceleration	Target acceleration value	RW	0
	610	1	Moving	moving	R	-
	611	4	Present position	Current position value	R	-
	615	4	Present velocity	Current velocity	R	-
	621	2	Present Current	Present current value	R	-
	623	2	Present input voltage	Current input voltage	R	-
	625	1	Present temperature	Current internal temperature	R	-
	626	2	External Port Data 1	External Port Data 1	R / RW	0
	628	2	External Port Data 2	External Port Data 2	R / RW	0
	630	2	External Port Data 3	External Port Data 3	R / RW	0
	632	2	External Port Data 4	External Port Data 4	R / RW	0
	634	1	Indirect Data 1	Indirect Data 1	RW	0
	635	1	Indirect Data 2	Indirect Data 2	RW	0
	636	1	Indirect Data 3	Indirect Data 3	RW	0
	Indirect Data N	Indirect Data N ...	RW	0
	889	1	Indirect Data 256	Indirect Data 256	RW	0
890	1	Registered Instruction	Registered Instruction value	R	0	
891	1	Status Return Level	Status Return Level value	RW	2	
892	2	Hardware error status	Hardware error status value	R	0	

2.3 Features (by width size)

2.3.1 54-series (H54, M54, L54)



2.3.2 42-series (H42, L42)



2.4 Dimensions

2.4.1 H Series

i. H54-200-S500-R

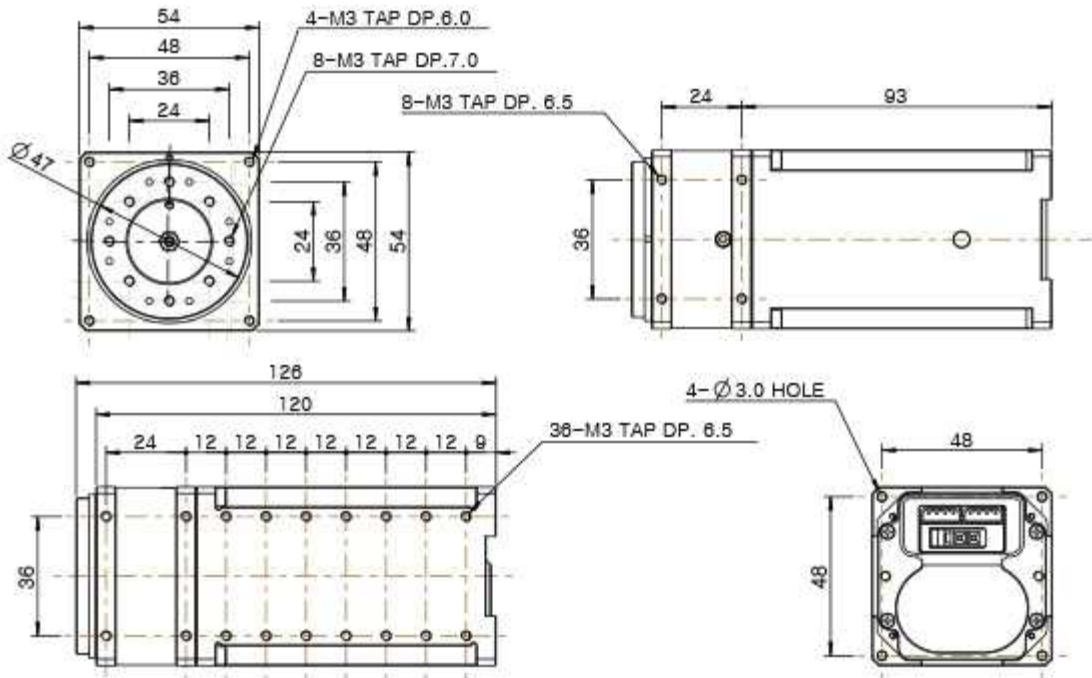

ii. H54-100-S500-R

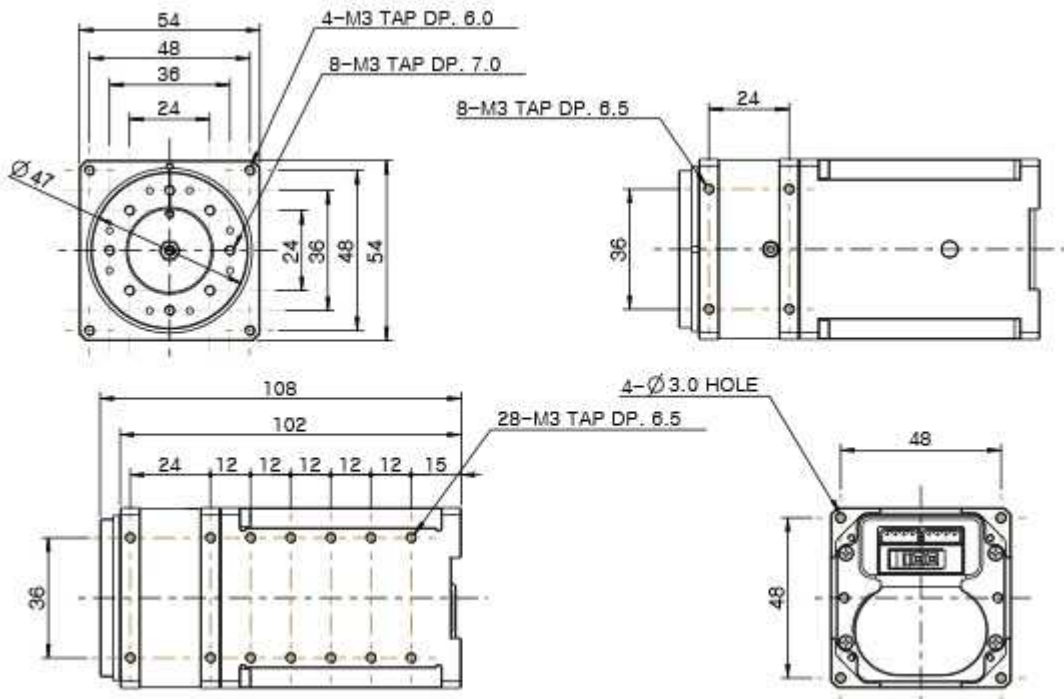

iii. H42-20-S300-R

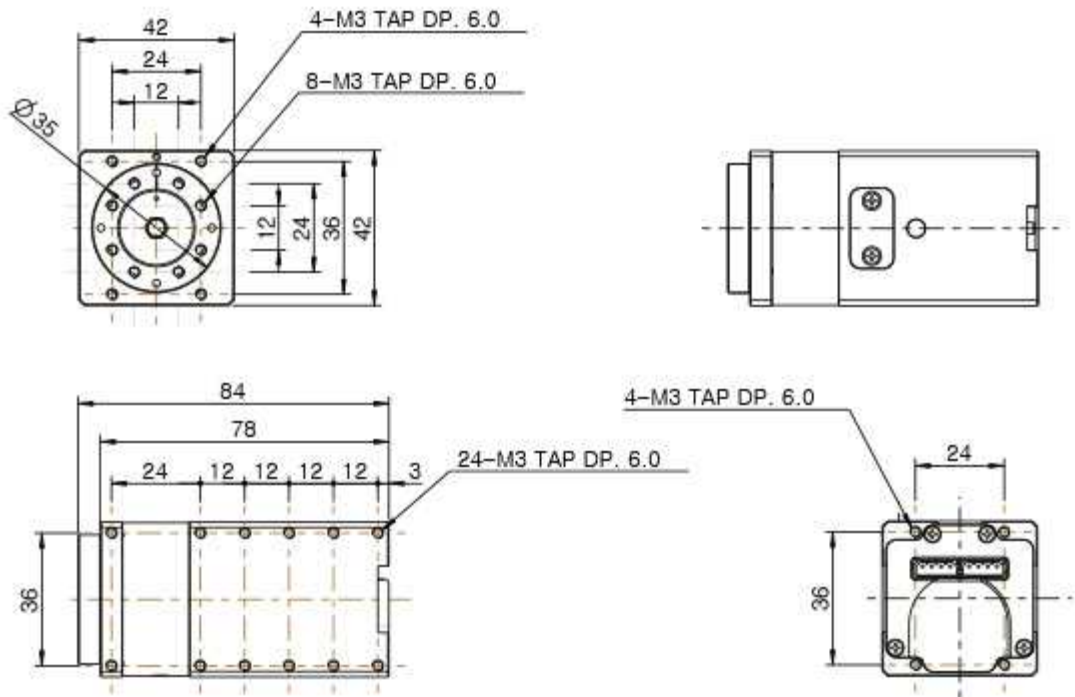

2.4.2 M Series

i. M54-60-S250-R

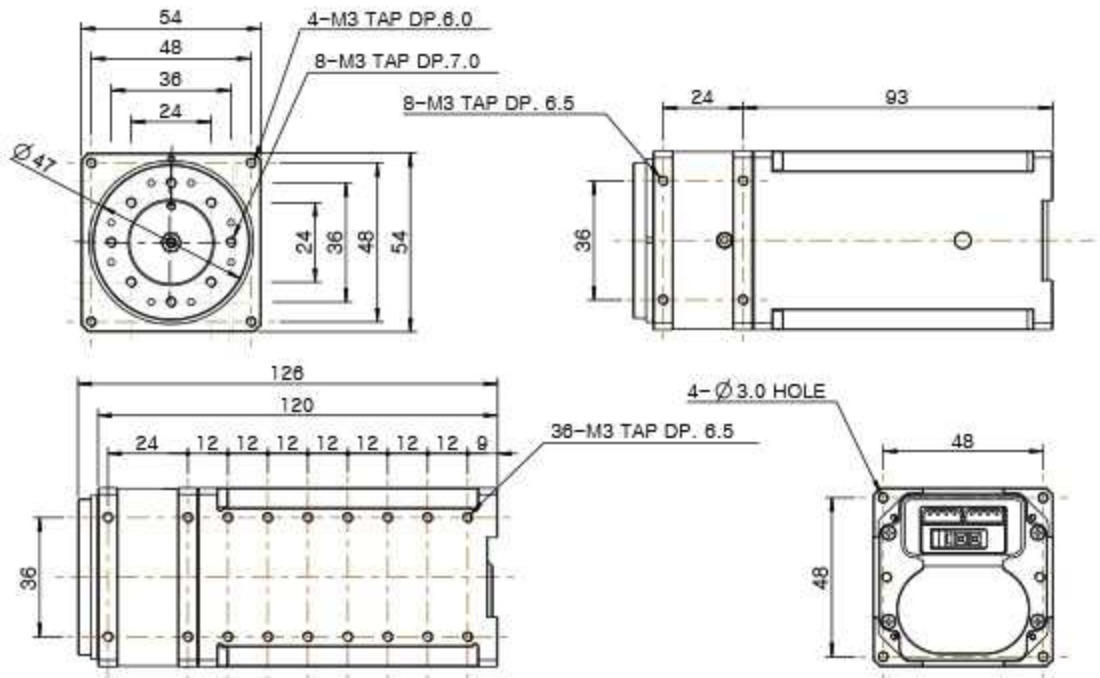

ii. M54-40-S250-R

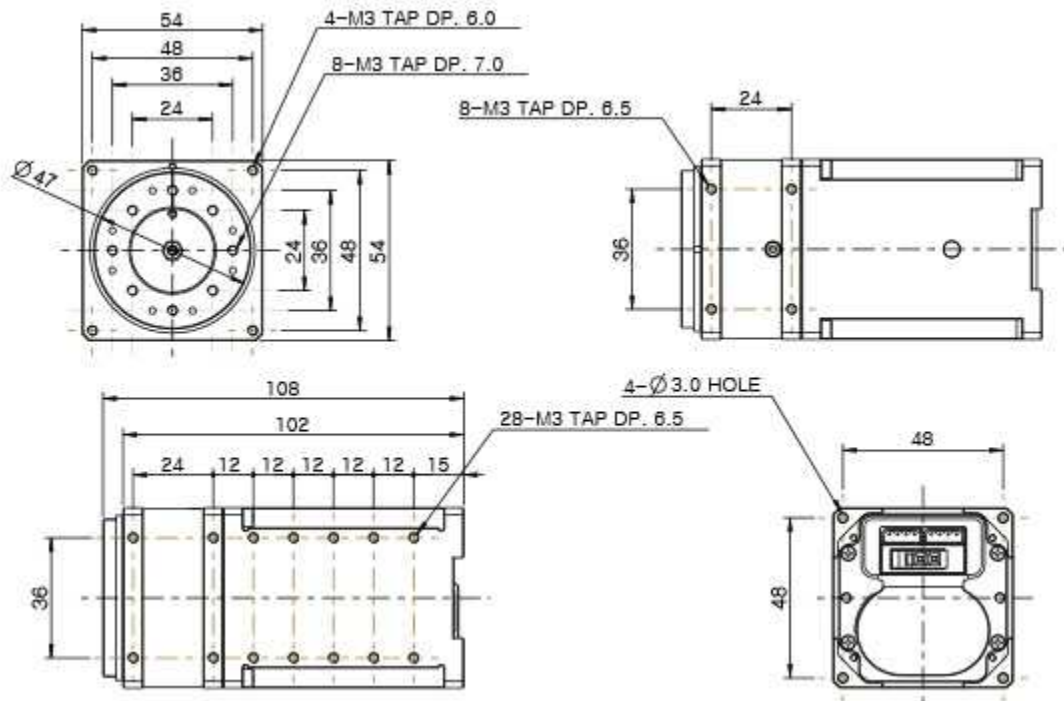

2.4.3 L Series

i. L54-50-S290-R

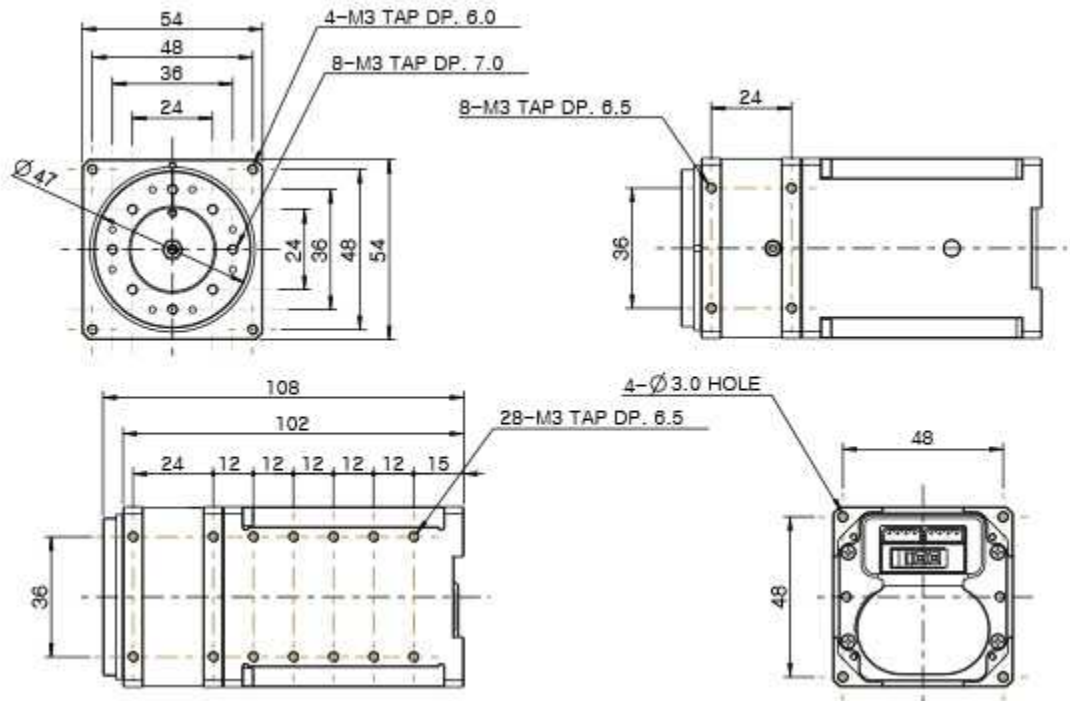

ii. L54-30-S400-R

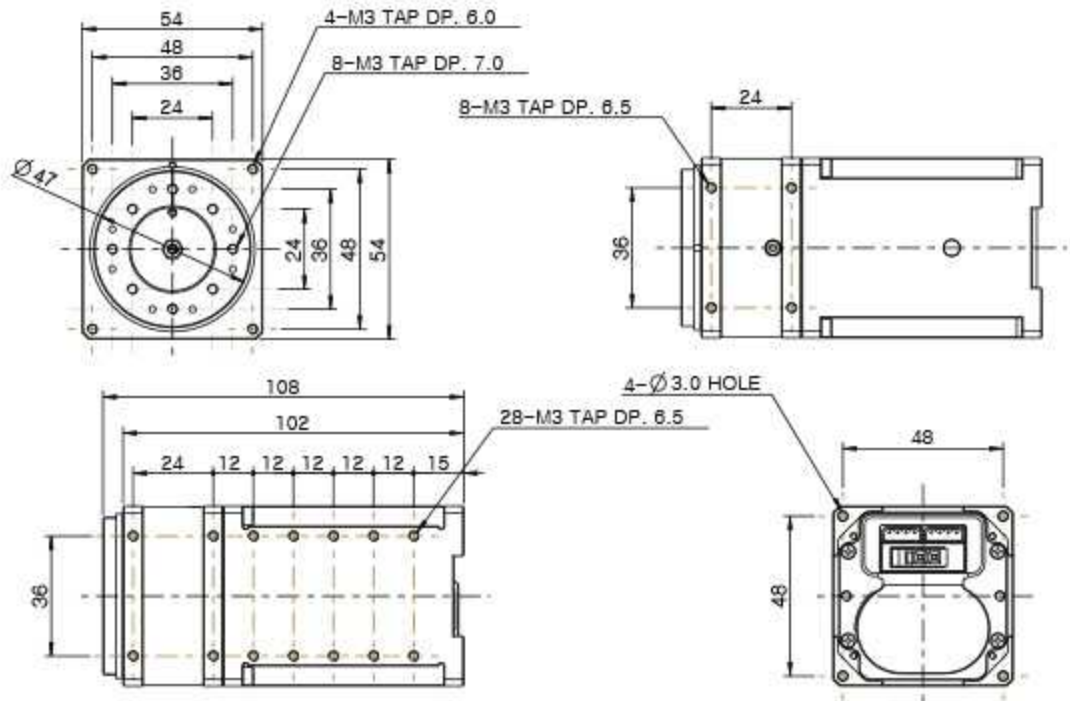

iii. L42-10-S300-R

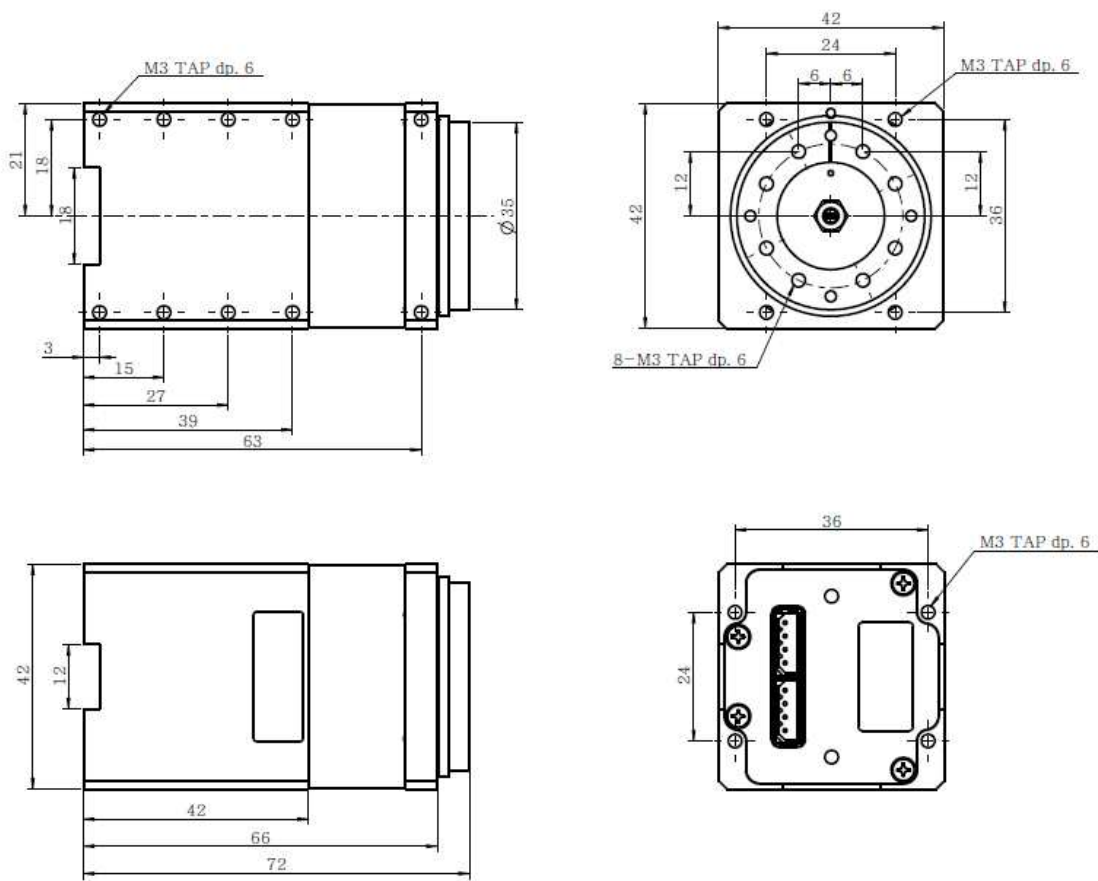

2.5 Model notation

